



OpenAir™

Air damper actuators

GDB...1
GLB...1
GSF...1

Rotary version, AC 24 V / AC 230 V

Electronic motor driven actuators for three-position and modulating control, nominal torque 5 Nm (GDB), 10 Nm (GLB) or 2 Nm (GSF), mechanically adjustable span between 0...90°, pre-wired with 0.9 m long connection cables. Type-specific variations with adjustable offset and span for the positioning signal, position indicator, feedback potentiometer, self-adaption of rotational angle range and adjustable auxiliary switches for supplementary functions.

Remarks

This data sheet provides a brief overview of these actuators. Please refer to the Technical Basics in document Z4634en for a detailed description as well as information on safety, engineering notes, mounting and commissioning.

Use

- For damper areas up to 0.8 m² (GDB) / 1.5 m² (GLB), friction-dependent for GSF...1 up to 0.3 m²
- Suitable for use with modulating controllers (DC 0...10 V) or three-position controllers for air dampers or air throttles.

Type summary

GDB.../GLB...	131.1E	132.1E	136.1E	331.1E	332.1E	336.1E	161.1E	163.1E	164.1E	166.1E
GSF...							161.1E			
Control type	Three-position control						Modulating control			
Operating voltage AC 24 V	X	X	X				X	X	X	X
Operating voltage AC 230 V				X	X	X				
Positioning signal Y DC 0...10 V							X			X
DC 0...35 V with characteristic function $U_0, \Delta U$								X	X	
Position indicator $U = DC 0...10 V$							X	X	X	X
Feedback potentiometer 1 k Ω		X			X					
Self-adaption of rotational angle range							X	X	X	X
Auxiliary switches (two)			X			X			X	X
Rotary direction switch							X	X	X	X

Functions

Type	GDB.3..1 / GLB.3..1	GDB16..1 / GLB16..1 / GSF16..1
Control type	Three-position control	Modulating control
Positioning signal with adjustable characteristic function		Y = DC 0...35 V at Offset $U_0 = 0...5 V$ Span $\Delta U = 2...30 V$
Rotary direction	Clockwise or counter-clockwise direction depends... ...on the type of control. With no power applied, the actuator remains in the respective position.	
Position indication: Mechanical	Rotary angle position indication by using a position indicator.	
Position indication: Electrical	The feedback potentiometer can be connected to external voltage to indicate the position.	Position indicator: Output voltage $U = DC 0...10 V$ is generated propor- tional to the rotary angle. U depends on the rotary direction of the DIL switch setting.
Auxiliary switch	The switching points for auxiliary switches A and B can be set independent of each other in increments of 5° within 0° to 90°.	
Self-adaption of linear span		When self-adaption is active, the actuator auto- matically determines the mechanical end positions of the linear span and maps the characteristic function ($U_0, \Delta U$) to the calculated linear span.
Manual adjustment	The actuator can be manually adjusted by pressing the gear train disengagement button	
Rotary angle limitation	The rotary angle of the shaft adapter can be limited mechanically with a socket head cap screw.	

Ordering

Note

Potentiometer and auxiliary switches **cannot be added in the field**. For this reason,
order the type that includes the required options.

Accessories, spare parts

Accessories to functionally extend the actuators are available, e.g., rotary/linear sets,
see data sheet **N4698**.





دقیق صنعت پیشرو

اتوماسیون و سیستمهای کنترل

Building Technologies

HVAC Products

Technical data

 AC 24 V supply (SELV/PELV)	Operating voltage / Frequency	AC 24 V ± 20 % / 50/60 Hz
	Power consumption GDB13..1/GLB13..1 Running	2 VA / 1 W
	GDB16..1/GLB16..1 Running	3 VA / 2 W
	Holding	1 W
	Power consumption GSF16..1 Running	4 VA / 3.7 W
	Holding	2 W
 AC 230 V supply	Operating voltage / Frequency	AC 230 V ± 10 % / 50/60 Hz
	Power consumption GDB33..1/GLB33..1 Running	2 VA / 1 W
	Function data	
	Nominal torque	5 Nm (GDB)/ 10 Nm (GLB)/ 2 Nm (GSF)
	Maximum torque (blocked)	7 Nm (GDB)/ 19 Nm (GLB)/ 3.5 Nm (GSF)
	Nominal rotary angle / Max. rotary angle	90° / 95° ± 2°
	Runtime for 90° rotary angle (GDB/GLB)	150 s (50 Hz) / 125 s (60 Hz)
	(GSF)	20 s (50 Hz) / 17 s (60 Hz)
Positioning signal for GDB16..1/GLB16..1/GSF16..1	Input voltage Y (wires 8-2)	DC 0...10 V
	Max. permissible input voltage	DC 35 V, internally limited to DC 10 V
Characteristic functions for GDB/GLB/GSF161.1/ GDB/GLB166.1 GDB/GLB163.1, GDB/GLB164.1	Input voltage Y (wires 8-2)	DC 0...35 V
	Non-adjustable characteristic function	DC 0...10 V
	Adjustable characteristic function Offset U _o	DC 0...5 V
	Span ΔU	DC 2...30 V
Position indicator for GDB/GLB/GSF16...1	Output voltage U (wires 9-2)	DC 0...10 V
	Max. output current	DC ± 1 mA
Feedback potentiometer for GDB/GLB132.1, GDB/GLB332.1	Change of resistance (wires P1-P2)	0...1000 Ω
	Load	< 1 W
 Auxiliary switches for GDB../GLB..6.1, GDB/GLB164.1	Contact rating	6 A resistive, 2 A inductive
	Voltage (no mixed operation AC 24 V / AC 230 V)	AC 24...230 V
	Switching range for auxiliary switches	5°...90°
	Setting increments	5°
Connection cables	Cross-section	0.75 mm ²
	Standard length	0.9 m
Degree of protection of housing	Degree of protection as per EN 60 529 (note mounting instructions)	IP 54
Protection class	Insulation class	EN 60 730
	AC 24 V, feedback potentiometer	III
	AC 230 V, auxiliary switch	II
Environmental conditions	Operation / Transport	IEC 721-3-3 / IEC 721-3-2
	Temperature	-32...+55 °C / -32...+70 °C
	Humidity (non-condensing)	< 95% r. F. / < 95% r. F.
Standards and directives	Product safety: Automatic electrical controls for household and similar use	EN 60 730-2-14 (Type 1)
	Electromagnetic compatibility (EMC):	
	Immunity for all models, except GDB/GLB.32.1x	IEC/EN 61 000-6-2
	Immunity for GDB/GLB.32.1x	IEC/EN 61 000-6-1
	Emission for all types	IEC/EN 61 000-6-3
	 Conformity: Electromagnetic compatibility	89/336/EWG
	Low voltage directive	73/23/EWG
	 Conformity: Australian EMC Framework	Radio Communication Act 1992
	Radio Interference Emission Standard	AS/NZS 3548
	Dimensions	
Actuator W x H x D (see "Dimensions")	68 x 137 x 59.5 mm	
Damper shaft:	round	8...16 mm
	round with centering element	8...10 mm
	4-kant	6...12.8 mm
	Min. shaft length	30 mm
	Shaft hardness	< 300 AV
Weight	Without packaging:	0.48 kg

Disposal

The document on technical basics and the environmental declaration provide information on environmental compatibility and disposal of this device.

Internal diagrams

Three-position control

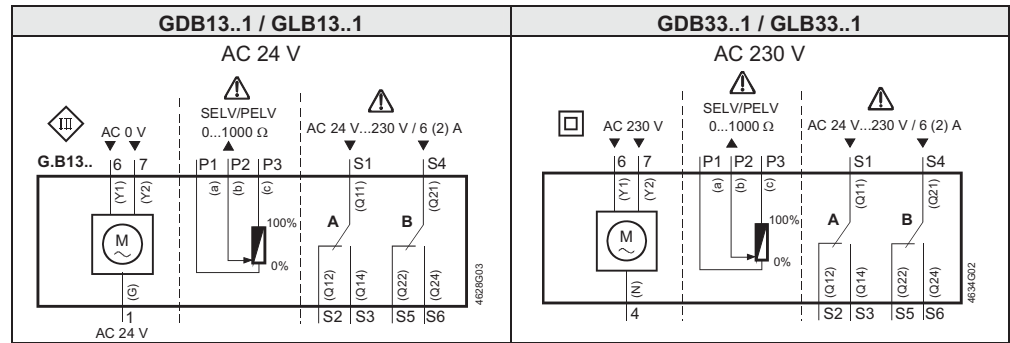

Modulating control

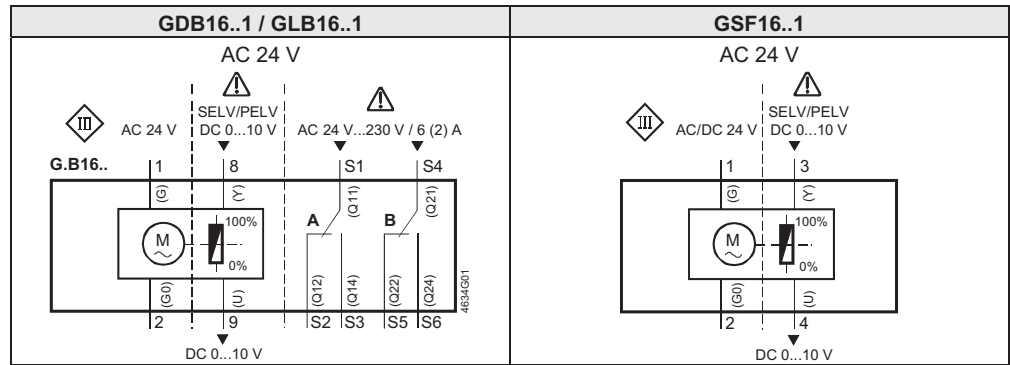

Cable labeling

Pin	Cable			Meaning
	Code	No.	Color Abbreviation	
Actuators AC 24 V	G	1	red RD	System potential AC 24 V
	G0	2	black BK	System neutral
	Y1	6	purple VT	Position signal AC 0 V, clockwise
	Y2	7	orange OG	Position signal AC 0 V, counter-clockwise
	Y	8	grey GY	Position signal DC 0..10 V, 0..35 V
	U	9	pink PK	Position indication DC 0..10 V
Actuators AC 230V	N	4	blue BU	Neutral conductor
	Y1	6	black BK	Control signal AC 230 V, clockwise
	Y2	7	white WH	Control signal AC 230 V, counter-clockwise
Auxiliary switch	Q11	S1	grey/red GY RD	Switch A Input
	Q12	S2	grey/blue GY BU	Switch A Normally closed contact
	Q14	S3	grey/pink GY PK	Switch A Normally open contact
	Q21	S4	black/red BK RD	Switch B Input
	Q22	S5	black /blue BK BU	Switch B Normally closed contact
	Q24	S6	black /pink BK PK	Switch B Normally open contact
Feedback potentiometer	a	P1	white /red WH RD	Potentiometer 0...100 % (P1-P2)
	b	P2	white /blue WH BU	Potentiometer pick-off
	c	P3	white /pink WH PK	Potentiometer 100...0 % (P3-P2)

Dimensions

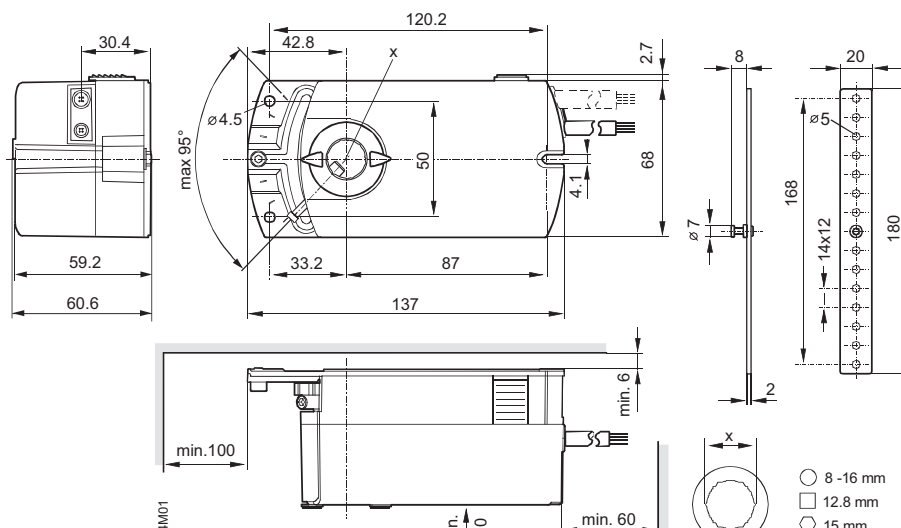

دقیق صنعت پیشرو

اتوماسیون و سیستمهای کنترل

Building Technologies

HVAC Products