

Modbus Air Pressure Sensor with I/O extension

QBM3700..



QBM3700.. air pressure sensor with I/O extension is designed for Modbus RTU communication networks. The QBM3700.. offers easy installation and less plant wiring with HVAC industry wide proven sensor technology.

- Modbus RTU communication interface
- Two analog inputs for 0...10 V or passive temperature elements
- Two analog outputs for 0...10 V
- Available with a differential pressure sensor element
- Pressure sensor elements with high accuracy and long-term stability via ceramic strain-gauge technology at different pressure ranges from 0...500 – 2500 Pa
- Decentralized node provides simple installation and less wiring
- DIP switches for addressing and Modbus line termination
- Push button for automated on-event addressing together with Siemens Climatix controllers

QBM3700.. Modbus air pressure sensor with I/O extension

The QBM3700.. comes with one sensor element and with different pressure ranges for power and communication.

QBM3700..



Type / ASN	Order number / SSN	Pressure range	Inputs/ outputs	MOQ
Types with 1 sensor				
QBM3700-5/MO	S55720-S487	1x 0...500 Pa	2 AI, 2 AO	1
QBM3700-13/MO	S55720-S485	1x 0...1250 Pa	2 AI, 2 AO	1
QBM3700-25/MO	S55720-S486	1x 0...2500 Pa	2 AI, 2 AO	1

Ordering

When ordering a QBM3700.. Modbus air pressure sensor with I/O extension, please specify the quantity and type.



Please observe the minimum order quantity (MOQ). One ASN order equals a box with one sensor.

Please contact your Siemens sales regional center for other QBM3700.. types or custom orders.

Accessories

Type / ASN	Order number / SSN	Designation
FK-PZ1	BPZ:FK-PZ1	Air duct probe for differential pressure sensor, short, adjustable
FK-PZ2	BPZ:FK-PZ2	Air duct probe for differential pressure sensor, long, adjustable
FK-PZ3	BPZ:FK-PZ3	Air duct probe for differential pressure sensor, fixed length

Focus segment

- Air handling units (AHU), with communication between controller and field devices and connected to cloud enabling plant digitalization.
- Support of Ecodesign directive ErP 2016/2018 through the use of bus-compatible sensors for monitoring filters, including cloud visualization.

Typical use

The QBM3700.. Modbus air pressure sensor and I/O extension is used in ventilation systems and air handling units (AHU):

- To measure and monitor pressure in air ducts and over filters and fans
- On the supply and extract air side

The QBM3700.. is ideally suited for a multitude of tasks in the HVAC industry:

- Measures relative and differential pressure and flow of air and non-aggressive gases
- Available with a differential pressure sensor
- Allows monitoring of pressure or volume flow at two individual points in the system

Topology

AHU topology with Modbus field devices and sensors

- The following digital AHU topology illustrates an example for using the QBM3700..

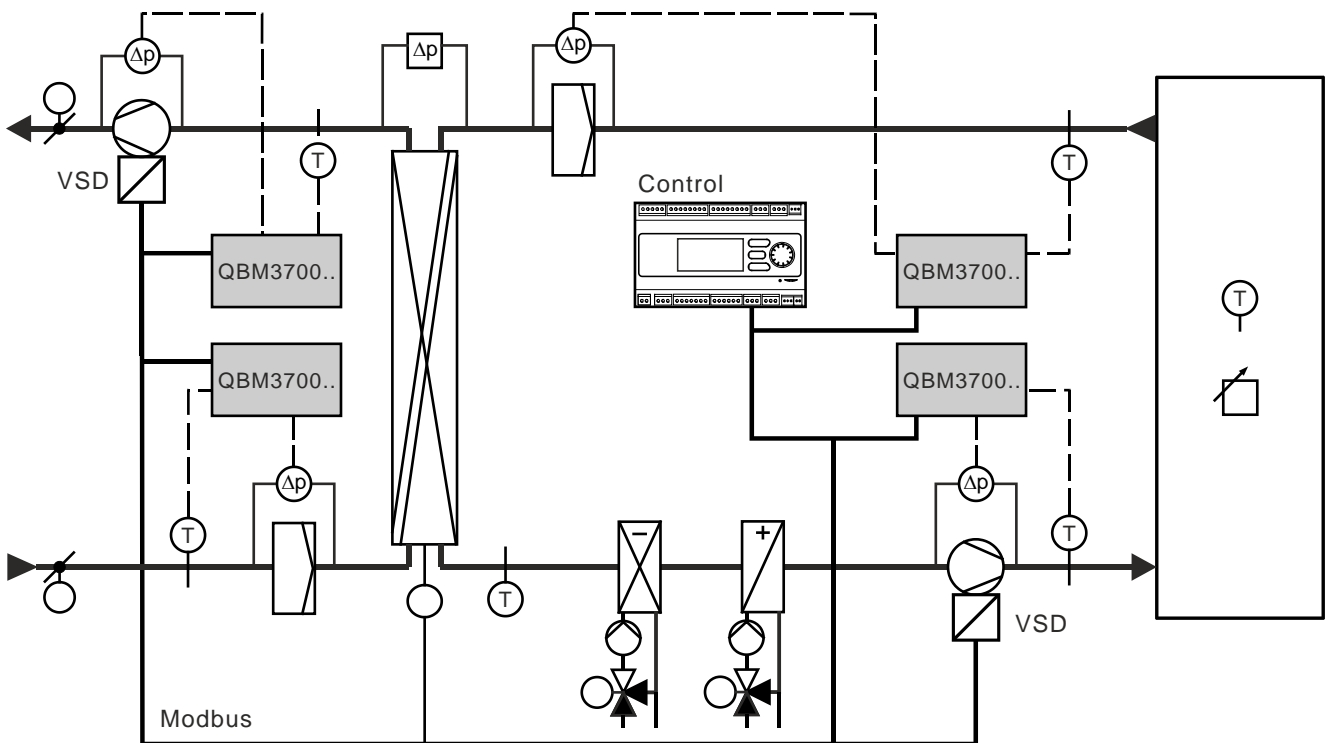

Sensor technology

The built-in sensors of the QBM3700.. are based on the unique and in HVAC and automotive industry well-proven ceramic strain-gauge beam technology.

- The accurate sensors with long-term stability for all measured variables are completely maintenance free, providing cost savings over the life of the plant.
- The sensor elements are also suited for demanding applications in the food or pharmaceutical industry.

• The sensor elements are also suited for demanding applications in the food or pharmaceutical industry. Decentralized node via Modbus (RTU) combined with inputs/outputs

The QBM3700.. with its Modbus communication interface is a decentralized node, when using the inputs and outputs for sensors and field devices:

- For example temperature sensors can be linked to the analog inputs and actuators linked to the analog outputs.
- Having these elements on Modbus reduces wiring and installation costs.

Innovative housing design with quick release fasteners

The housing of the QBM3700.. comes with quick release fasteners, which can be pushed in by hand, making screws and tools for opening and closing the sensor unnecessary. The innovative housing design is based on a patented sealing, injected directly during the plastic injection molding process. A high protection grade of IP54 is guaranteed, providing a wide range of application areas.



Workflows and "How to instructions" are available in document A6V11841988. See Section Supplemental information [→ 11].

DIP switches for addressing and Modbus line termination

For flexible use and wide range of application the QBM3700.. Modbus air pressure sensor with I/O extension can be addressed via its DIP switches with controllers other than Climatix controllers.

Push button for automated on-event addressing together with Climatix controllers

The QBM3700.. can be paired (addressed) easily and fast with Climatix controllers with the inbuilt push button for on-event addressing. On-event push button addressing is implemented in Siemens Modbus sensors and devices for digital air handling units (AHU), providing a consistent, easy and fast commissioning process for manufacturers and installers.

Zero point factory reset

Resetting to factory settings or zero point is easy.

Siemens as global technology partner

The QBM3700.. is distributed globally via the Siemens sales network. . The sensor is tested according to the major international standards such as EU and RCM conformity, UL approbation and EAC, making possible a worldwide field of application. Continuous innovations and development, as well as sustained quality, logistic processes, spare parts management and customer support make Siemens a valued technology partner.

PCB overview

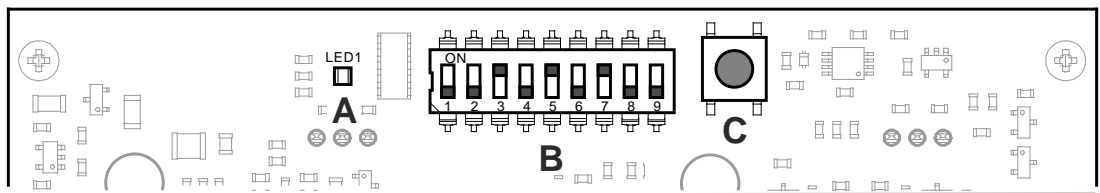

Element	Description
A	Status LED
B	DIP switches
C	Button

Status LED indicator

Color	Flashing	Function
Red	Blinking, 1 sec. on, 5 sec. off	<ul style="list-style-type: none"> Internal error
Red	Blinking, 0.1 second on, 1 second off	<ul style="list-style-type: none"> Invalid configuration
Orange	Modulating	<ul style="list-style-type: none"> Waiting for on-event addressing
Orange	Blinking, 1 sec. on, 5 sec. off	<ul style="list-style-type: none"> Bus communication failure
Orange	Blinking, 0.1 second on, 1 second off	<ul style="list-style-type: none"> Device not configured (factory settings)
Green	Modulating	<ul style="list-style-type: none"> Start-up
Green	Flashing	<ul style="list-style-type: none"> Normal operation
Green	Flickering	<ul style="list-style-type: none"> Bus communication
Blue	Modulating	<ul style="list-style-type: none"> Zero point reset



Workflows and 'How to instructions' for the DIP switches and the push button can be found in A6V11841988. See Section Supplemental information [→ 11].

DIP switches

- Use DIP switches for adjustment of the Modbus address (DIPs 1 to 8) and for Modbus line termination (DIP 9).
- The DIP switches have priority over register 'Modbus address'.

Button

Duration of operation	Function
5...10 s	On-event addressing
10...20 s	Zero point reset
20...30 s	Reset to factory setting

Terminal

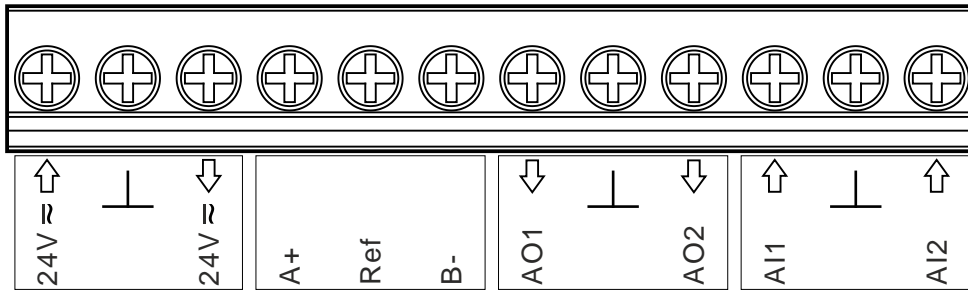

Terminal	Description
24 V \approx \rightarrow	Power AC 24 V / DC 24 V
\perp	GND
24 V \approx \rightarrow	Power for external device AC 24 V / DC 24 V
A+, REF, B-	Modbus, RS-485 NOTICE! Not galvanically separated
AO1 \leftarrow	Analog output 1
\perp	GND
AO2 \leftarrow	Analog output 2
AI1 \rightarrow	Analog input 1
\perp	GND
AI2 \rightarrow	Analog input 2

Technical data

Power data

Power supply	
Operating voltage	AC/DC 24 V \pm 15 %
Frequency	50/60 Hz
Protection class	III (SELV / PELV), UL class 2 NOTICE! Limited energy circuit 15 VA or less.
Power consumption	<2 VA
Current draw	AC max. 25 mA @ AC 24 V
Current draw DC	25 mA @ DC 24 V
24V external power supply for active sensors	Max current: 80 mA

Function data

Expositions	
Ranges	See "Type overview / order data [\rightarrow 2]".
Variables	Pa, Psi, mmHG, mmH ₂ O (configured via application)
Sensing element	Piezo resistive <ul style="list-style-type: none">• Ceramic bar: Al₂O₃ (96%)• Diaphragm: Silicone
Accuracy	Accuracy Total measuring accuracy at required installation position and r.H. 45% <ul style="list-style-type: none">• Device 0...500 Pa, at 20°C: $\leq \pm$ 1% FS• Device 0...1250 Pa, at 20°C: $\leq \pm$ 0.5% FS• Device 0...2500 Pa, at 20°C: $\leq \pm$ 0.5% FS• Device 0...500 Pa, at 0...50°C: $\leq \pm$ 2% FS• Device 0...1250 Pa, at 0...50°C: $\leq \pm$ 1% FS• Device 0...2500 Pa, at 0...50°C: $\leq \pm$ 1% FS (Remark: FS = Full Scale)
	Long-term stability: \pm 1.0% FS as per DIN EN 60770, resolution <0.1% FS
Response time	<1 s

Limits	
Tolerable overload on one side	<ul style="list-style-type: none"> On P_x +: 10000 Pa On P_x -: 400 Pa
Rupture pressure	<ul style="list-style-type: none"> At room temperature: 2x overload At 70 °C: 1.5x overload
Media / Admissible temperature	Air and neutral gases / 0...70 °C

Data for volume flow calculation	
Permitted k factor range	0...1500
Formula	$Q = k \times \sqrt{\Delta p}$
Measured variables	l/s, m ³ /h, m ³ /s

	NOTICE
	<p>Accuracy of volume flow calculation</p> <p>The accuracy of the volume flow calculation is proportional to the root of the pressure measurement accuracy multiplied by the k-factor.</p>

Additional data	
Pressure connections	∅ 6.2 mm, (for pipe inside ∅ 5 mm)
Maintenance	Maintenance free

Modbus RTU communication

Element	Specification
Address range	1...247 (255 = Default)
Baud rate	9'600...57'600
Format	Modbus RTU
Line termination	Selectable via DIP switch 9
Hardware	RS485
Default configuration	9600E1 (9600 baud rate, 1 stop bit, even parity)

Cable types

Interface	Specification
Signal lines (Inputs/ outputs)	Screw terminals for wire and stranded conductors: <ul style="list-style-type: none">• Wire: 0.5...2.5 mm² NOTICE! Use only copper wiring
Cable bushings	<ul style="list-style-type: none">• QBM3700.. screwed connectors<ul style="list-style-type: none">– 2 x cable glands screwed for cable \varnothing 3...6 mm (wrench size 15 mm)– 2 x cable glands screwed for cable \varnothing 5...10 mm (wrench size 20 mm)
Modbus	Modbus 2 or 3-wire, twisted, shielded, if >3 m

Wire lengths

Interface	Wire lengths
Signal wiring	Max. 50 m
Modbus	Max. 100 m

Inputs and outputs

Analog inputs AI1, AI2				
Type	Area	Accuracy	Resolution	TK/B _{25/85}
Pt1000	-50...+150 °C	±0.5 K	0.1 K	3850 ppm/K
LG-Ni1000	-40...+120 °C	±0.5 K	0.1 K	5000 ppm/K
NTC10k	-40...-25 °C	±1.0 K	0.2 K.	3979
	-25...+75 °C	±0.5 K	0.1 K	3979
	+75...+100 °C	±1.0 K	0.3 K	3979
	+100...+125 °C	±3.0 K	1.0 K	3979
	+125...+150 °C	±6.0 K	2.5 K	3979
Ni1000	-50...+150 °C	±0.5 K	0.1 K	6180 ppm/K
Input DC 0...10 V	0 V	±5 mV	<5 mV	-
	5 V	±25 mV	<5 mV	-
	10 V	±50mV	<5 mV	-
Input resistance	≥100 kΩ			



Configuration of AI1 and AI2 is done via application/HMI.

Analog outputs AO1, AO2			
Type	Voltage	Resolution	Accuracy
Output DC 0...10 V	0 V	<11 mV	±66 mV
	5°V	<11 mV	±95 mV
	10 V	<11 mV	±124 mV
<ul style="list-style-type: none"> • Output current: Max. 1 mA (short-circuit proof) • Min. load: 10 kΩ 			

Conformity

Ambient conditions and protection classification	
Classification as per EN 60730	-
Degree of pollution	3
Impulse voltage	330 V
Degree of protection of housing to EN 60529	IP54
Climatic ambient conditions as per EN 60721-3	<ul style="list-style-type: none"> Temperature: -30...+70 °C Air humidity: 5...90 % (non-condensing)
Transport/storage	
Operating	<ul style="list-style-type: none"> Temperature: -25...+50 °C Air humidity: 5...90 % (non-condensing)

Standards, directives and approvals	
Product standard	EN 60730-1 Automatic electronic controls for household and similar use
Electromagnetic compatibility	For residential, commercial, and industrial environments
EU conformity (CE)	A5W00050769_en
RCM Conformity	A5W00050770_en
UL approbation	ANSI/UL 60730-1 http://database.ul.com
EAC	Eurasian compliance
Environmental compatibility	The product environmental declaration (A6V11616725_e) contains data on environmentally compatible product design and assessments (RoHS compliance, materials composition, packaging, environmental benefit, disposal).

Housing and weight

Housing	
Material, Color/look	<ul style="list-style-type: none"> Polycarbonate PC / Polyamide (PA) Transparent
Dimensions	See "Dimensions [→ 14]"

Weight	
QBM3700..	~250 g

Supplemental information		
Document title	Topic	Document no:
User guide: Modbus air pressure sensor with I/O extension: QBM3700..	Installation, commissioning, engineering, maintenance and Modbus registers	A6V11841988

The documents can be downloaded at <http://siemens.com/bt/download>.

Safety: National regulations

	⚠ CAUTION
	<p>National safety regulations</p> <p>Failure to comply with national safety regulations may result in personal injury and property damage.</p> <ul style="list-style-type: none"> • Observe national provisions and comply with the appropriate safety regulations.

Mounting**Mounting location**

QBM3700.. air pressure sensor with I/O extension is suited for direct mounting on air ducts, walls, or in control panels. The following points must be observed.

Detailed information on mounting is available in document A6V11841988. See Supplemental information [→ 11].

	NOTICE
	<p>Inaccurate measurements due to wrong mounting location.</p> <p>An environment subject to high pressure pulses and/or significant thermal changes can lead to inaccurate measurements and/or zero shift.</p> <ul style="list-style-type: none"> • Avoid the these kinds of mounting locations. • A zero shift can be corrected with the function zero point reset.

Mounting location

	NOTICE
	<p>Condensation and damage to the device</p> <p>If the pressure connection nipples point upwards or are at a lower level than the air duct probes, condensation can collect inside the sensor, causing damage to the device.</p> <ul style="list-style-type: none"> • Mount QBM3700.. vertically with pressure nipples facing down. • Mount QBM3700.. higher than the duct probes.

Connecting tubes

	NOTICE
	<p>Damage to the device when mounting or removing the device.</p> <p>The device can be damaged, if the system is not depressurized when mounting or removing it.</p> <ul style="list-style-type: none"> • Depressurize the system prior to mounting or removing the sensor.

The pressure tubing for the sensor nipples are connected as following to the differential pressure sensor:

On the air duct side	On the pressure sensor side
Tubing with higher pressure side (lower vacuum)	Connect to pressure nipple "+".
Tubing with lower pressure side (higher vacuum)	Connect to pressure nipple "-".

Wiring

	<p>NOTICE</p>
	<p>Polarity reversal protection</p> <p>The device is short circuit proof and protected against polarity reversal. Each connection is protected against crossover up to maximum supply voltage.</p>

Disposal

	<p>The device is considered an electronic device for disposal in accordance with the European Guidelines and may not be disposed of as domestic garbage.</p> <ul style="list-style-type: none"> • Dispose of the device through channels provided for this purpose. • Comply with all local and currently applicable laws and regulations.
---	--

Dimensions

QBM3700.. (All dimensions in mm)

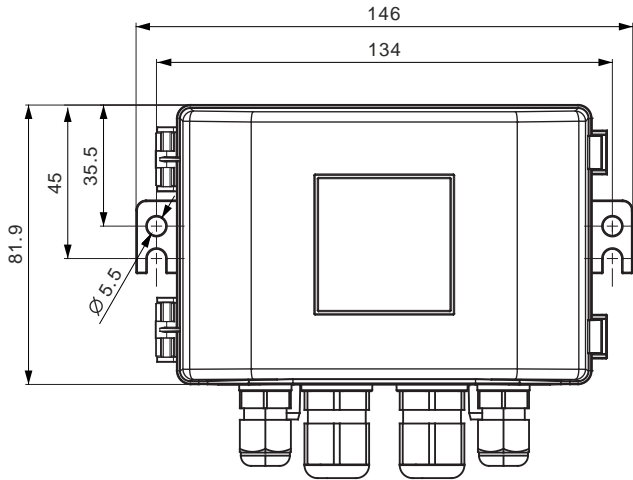

Front view QBM3700..

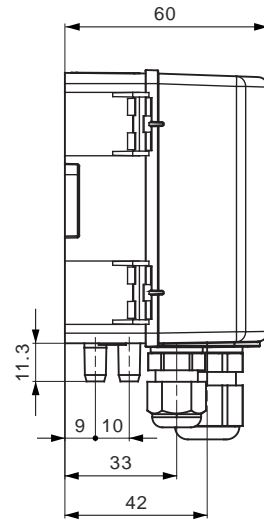

Side view QBM3700..

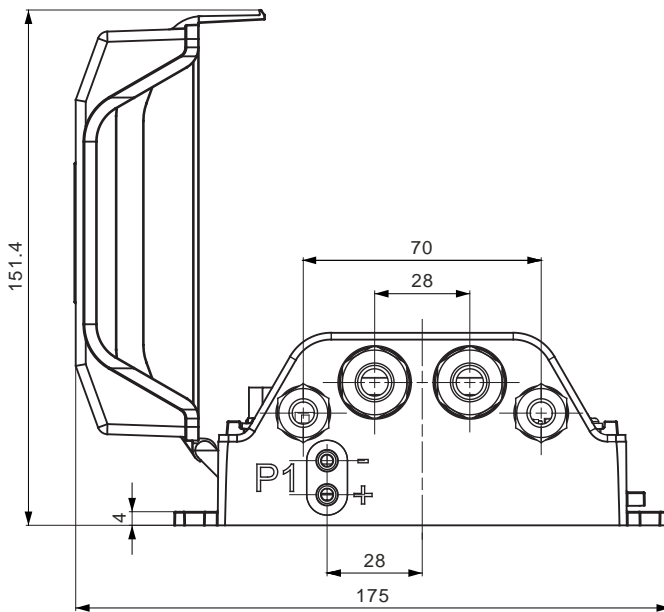

Bottom view QBM3700.. (opened cover)

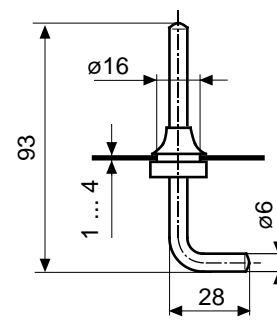

FK-PZ1

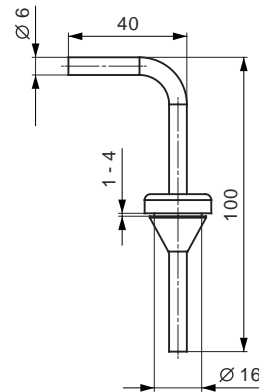

FK-PZ2

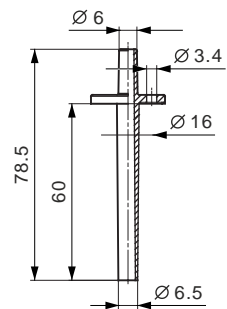

FK-PZ3