

Digital Multimeter

USER'S MANUAL

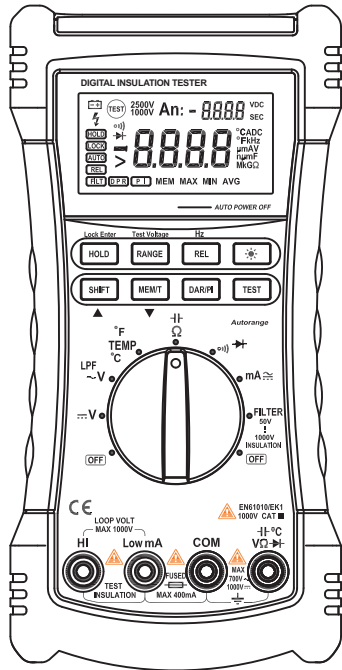

Digital Multimeter

CONTENTS

| | |
|------------------------------------|-----------|
| 1.SAFETY INFORMATION | 01 |
| 1.1 Warning | 01 |
| 1.2 Warranty | 02 |
| 1.3 Symbols | 02 |
| 2.INTRODUCTION | 03 |
| 2.1 Front Panel | 03 |
| 2.2 Display Screen | 04 |
| 2.3 Display Messages | 06 |
| 2.4 Buttons | 07 |
| 2.5 Rotary Switch | 08 |
| 2.6 Input Terminal | 10 |
| 3.FUNCTION DESCRIPTION | 11 |
| 3.1 Power-Up Options | 11 |
| 3.2 Automatic Power Off | 11 |
| 3.3 Fully loaded battery test | 12 |
| 3.4 Hold Function | 12 |
| 3.5 Relative Measurement | 12 |
| 3.6 Manual Ranging and Autoranging | 12 |

Digital Multimeter

CONTENTS

| | |
|---|-----------|
| 3.7 DAR&PI | 12 |
| 3.8 Insulation Test Lock | 13 |
| 3.9 Timer Function for insulation | 13 |
| 3.10 Data Recording | 15 |
| 4.MAKING BASIC MEASUREMENTS | 19 |
| 4.1 Measuring DC Voltage | 19 |
| 4.2 Measuring AC Voltage | 20 |
| 4.3 Measuring Temperature | 23 |
| 4.4 Measuring Resistance and Measuring Capacitance | 25 |
| 4.5 Measuring Continuity and Measuring Diode | 27 |
| 4.6 Measuring AC or DC Current | 29 |
| 4.7 Measuring frequency | 31 |
| 4.8 Insulation Test | 33 |
| 5.GENERAL SPECIFICATIONS | 36 |
| 6. ACCRUACY | 37 |
| 7.REPLACING BATTERY AND FUSE | 39 |
| 8.ACCESSORIES | 40 |

Digital Multimeter

1. INTRODUCTION

This style of digital multimeter is designed and manufactured according to the safety requirements set out by EN61010-1, EN61010-2-030 standards for electronic test instruments. Its design and manufacture is strictly based on the provisions in the 1000V CAT III, 600V CAT IV of IEC61010-1 and the Stipulation of 2-Pollution Grade.

1.1 Warning

To avoid possible electric shock or personal injury, follow these guidelines:

- Use the Meter only as specified in this manual or the protection provided by the Meter might be impaired.
- Do not use the Meter or test leads if they appear damaged, or if the Meter is not operating properly. If in doubt, have the Meter serviced.
- Always use the proper terminal, switch position, and range for measurements before connecting Meter to circuit under test.
- Verify the Meter's operation by measuring a known voltage.
- Do not apply more than the rated voltage as marked on the Meter, between the terminals or between any terminal and earth ground.
- Use caution with voltages above 30 V ac rms, 42 V ac peak, or 60 V dc. These voltages pose a shock hazard.
- Replace the battery as soon as the low battery indicator () appears.
- Disconnect circuit power and discharge all high-voltage capacitors before testing resistance, continuity, diodes, or capacitance.
- Do not use the Meter around explosive gas or vapor.

Digital Multimeter





When using the test leads, keep your fingers behind the finger guards.

- Remove test leads from the Meter before opening the Meter case or battery door.
- Never operate the Meter with the cover removed or the battery door open.
- Comply with local and national safety requirements when working in hazardous locations.
- Use proper protective equipment, as required by local or national authorities when working in hazardous areas.
- Use only the replacement fuse specified or the protection may be impaired.
- If the meter is dirty after usage, it is advised to clean it by using a humid cloth and mild house hold detergents.
- Never use acid detergent or dissolvants.

1.2 Warranty

The meter is warranted to be free from defects in material and workmanship under normal use and service. The warranty period is one year and begins on the date of shipment. Parts, product repairs, and services are warranted for 18 months except for misused, altered, neglected, contaminated, or damaged by accident or abnormal conditions of operation or handling. This warranty does not apply to fuses, disposable batteries.

1.3 Symbols

-  Dangerous Voltage
-  Ground
-  Warning see explain in manual
-  Double insulation
-  Fuse

Digital Multimeter

2.INTRODUCTION

This meter is a Digital Insulation Multimeter with broad range of measurement, which can be used to measure DC voltage, AC voltage, current, AC current, resistance, capacitance, frequency and temperature.

2.1 Front Panel

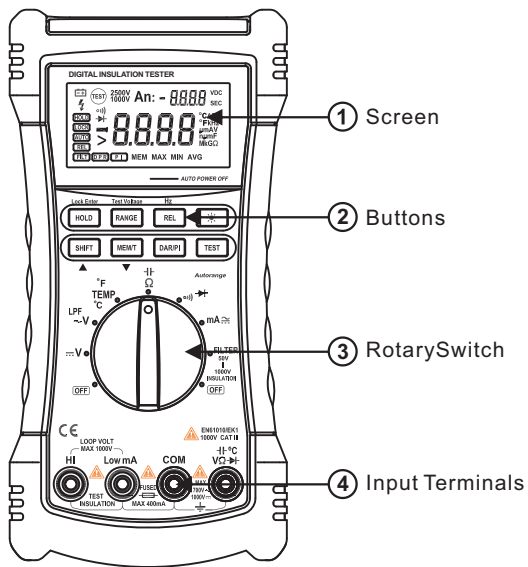





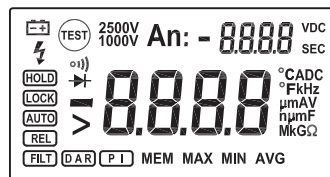

Digital Multimeter

2.2 Display Screen



| Indicator | Description |
|-----------|--|
| | Low battery Indicates when it is time to replace the battery. To avoid false readings, which could lead to possible electric shock or personal injury, replace the battery as soon as the low battery indicator appears. |
| | Indicates a test lock will be applied the next time you press Test Button on the meter, the test lock acts to hold down the button until you press Test Button again. |
| | Hold function, the meter do not update display. |
| | In multimeters function, Indicating the meter working in autorange function, else the meter work in manual range mode. |
| | Filter: when the rotary switch at $\sim V$ Position, the meter active 1KHz low passed filter; when the rotary switch at Insulation position, the meter active Smoothing function. |
| | Relative function. |
| | In insulation test mode, display the DAR value. |

Digital Multimeter

| Indicator | Description |
|---|---|
|  | In insulation test mode, display the PI value. |
|  | Minus, When the measure value lower than 0, display the sign. |
|  | Greater symbols, In insulation test mode, indicates the measure value overflow. |
|  | Unsafe voltage warning, In insulation mode, indicates greater 20V voltage is detected on the input terminals. |
| MEM | Indicates the meter working in Record mode, in this mode, meter can record the last 100 measure value |
| MAX MIN AVG | Display the Max, Min Avg value. |
| An: | In Record mode, indicates the counts of the recorded value |
| n: | Display the sequence number of the recorded value |
|  | Continuity test function is selected |
|  | Diode test function is selected |
| DC | DC Voltage or DC Current test function is selected |
| AC | AC Voltage or AC Current test function is selected |
| $^{\circ}$ CADC $^{\circ}$ FkHz μ mAV μ mV μ mF $\text{MkG}\Omega$ | Measurements Units |

Digital Multimeter

| Indicator | Description |
|---|---|
|  | Insulation test Indicator.when the rotary switch at insulation position, this sign appers, when the test voltage is present ,the sign alternate on or off |
| 2500V 1000V | Source voltage rating for insulation test |
| VDC | The measuring unit of source voltage rating for insulation test |
| SEC | Insulation Measuring time Unit |
| 8888 | Auxiliary Display :display the output voltage, time. |
| 8888 | Primary Display: display the measure value |

2.3 Display Messages

| Indicator | Description |
|--------------------|---|
| bat | Appears on Auxiliary display, Indicates the battery too low to perform Insulation test |
| POFF | The auto power off function is not activated |
| LIVE | In insulation mode,indicates meter have detected the voltage on the input terminals |
| DISC | In insulation mode,indicates the meter performs the auto discharge function; not to touch any input terminals in this mode. |
| OFF ^{SEC} | The Timer function is not activated |
| LEAD | Check the test leads in proper terminals,the rotary switch at current or insulation position, display the message |

Digital Multimeter

2.4 Buttons

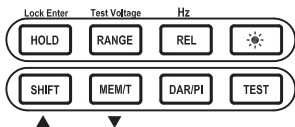

| Buttons | Description |
|---|--|
| <p>Lock Enter</p> <p>HOLD</p> | <ul style="list-style-type: none"> When rotary switch at the position except insulation, press the button, the display not updated When rotary switch at the insulation position, press the button toggle the test lock When rotary switch at the insulation position, and the meter in set measure time mode, press the button to save measure time and exit set-measure time mode |
| <p>SHIFT</p> <p>▲</p> | <ul style="list-style-type: none"> Shift:press this button to active the function higher rotary switch In Record mode,function as page up In Set-Measureing time mode, Increase the assign value |
| <p>Test Voltage</p> <p>RANGE</p> | <ul style="list-style-type: none"> When rotary switch at the position except insulation:press this button ,the meter will switch auto range to manual range. Press this button longer than 1S,the meter will switch manual range to autorange. When rotary switch at the insulation position, select a source voltage for Test. |

Digital Multimeter

| | |
|------------------------------|--|
| <p>MEM/T</p> <p>▼</p> | <ul style="list-style-type: none"> Activated the record function In Record mode,function as page down Activated the time function (When rotary switch at the insulation position) |
| <p>Hz</p> <p>REL</p> | <ul style="list-style-type: none"> Activated relative function Active the frequency measure function when rotary switch at AC voltage;press the button longer than 1S to perform the frequency measurement |
| <p>DAR/PI</p> | Display DAR or PI Value |
| <p></p> | Back Light on/Off,when the light turn on ,after 10S the meter auto turn off light |
| <p>TEST</p> | When rotary switch at the insulation position, press the button to perform insulation test |

2.5 Rotary Switch

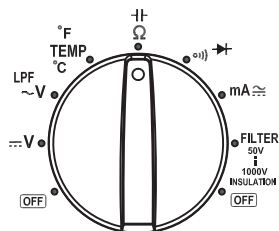

Digital Multimeter

| Position | Function |
|--|--|
| OFF | Turn off the meter power |
| $\text{DC } \text{V}$ | DC Voltage 0.1mV~1000V (Note : mV Range only exist in manual range) |
| LPF $\text{AC } \text{V}$ | 1 : AC Voltage 30mV~750V (note : mV Range only exist in manual range) 2 : Activated 1KHz low passed filter for AC voltage (do not use the Low-Pass Filter function to verify the presence of hazardous voltages) |
| $^{\circ}\text{F}$ TEMP $^{\circ}\text{C}$ | Celsius is the default temperature measurement unit press shift button switch to Fahrenheit measurement unit Temperature from -30°C to 1300°C (-22°F~2372°F) |
| Ω | Ohms : 0.1 Ω ~60M Ω Capacitance: 0.01nF~60mF |
| \rightarrow | Continuity Diode |
| mA | DC Current (0.01mA~400mA) AC Current (3.00mA~400mA) |
| FILTER 50V 1000V INSULATION | 1 : Insulation Test 0.01M Ω ~2.0G Ω , Test output Voltage 50V (default) 、100V、250V、500V、1000V, the test output voltage have selected will be saved . 2 : Digit filter function for Insulation test. |

Digital Multimeter

2.6 Input Terminal

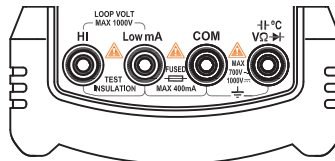

| Terminal | Description |
|--|---|
| $\text{HI-}^{\circ}\text{C}$ V Ω \rightarrow | Input positive terminal except current and insulation measure |
| COM | Common terminal except Insulation measure |
| Low mA | Input positive terminal for current measure, do not measure any current exceed 400mA (TRMS) |
| HI | Input positive terminal for Insulation measure |

Note 1 : To remind you to check that the test leads are in the correct terminals, LEAd is momentarily displayed when you move the rotary switch to mA or Insulation Position

Warning

To avoid a blown fuse, damage to the Meter, or serious personal injury, never attempt to make a measurement with a test lead in an incorrect terminal.

Digital Multimeter

3. Function Description

3.1 Power-UP Option

Holding a button down while turning the Meter on activates a power-up option. Power-up options allow you to use additional features and functions of the Meter. To select a power-up option, hold down the appropriate button indicated while turning the Meter from OFF to any switch position. Power-up options are cancelled when the Meter is turned OFF

| Buttons | Function |
|---------|--|
| SHIFT | Turns on all LCD segments. |
| MEM | Disables automatic power-off function Display shows PoFF until the button is released |
| TEST | Disable the timer of insulation function |
| DAR/PI | Initiates a fully loaded battery test and displays the charge level of the battery until the button is released. |

3.2 Automatic Power OFF

The Meter have automatic power off function (Sleep mode) to conserve battery power .if there is no function change or button press for 10 minutes. The Meter comes out of Sleep mode when a key is pressed or when the rotary switched is changed.

To disable the Sleep mode, hold down MEM button while turning the Meter on. Sleep mode is always disabled in the recording mode, insulation test active, or if the auto power off feature has been disabled by pressing MEM button when the Meter is turned on.

Digital Multimeter

3.3 Fully loaded battery test

Hold down DAR/PI button while turning the Meter on, the meter display the battery voltage.

Put up the DAR/PI button to exit battery voltage test.

3.4 Hold Funcion (rotary switch at the position except insulation)

Press Hold button to freeze the displayed value. Press again to release the display.

3.5 Relative Measurement

Show the difference between actual value and the relative base.

Press **REL** Button to enter relative measurement and the meter will record the initial value when pressing the key.

Displayed value = Actual value -Initial value

Press **REL** Button again to exit relative measurement.

3.6 Manual Ranging and Autoranging

To enter the Manual Range mode, press Range button and Auto is hide, In the Manual Range mode, press Range button to increment the range. After the highest range, the Meter wraps to the lowest range.

To exit Manual Range, press Range button for one second or turn the rotary switch. The Meter returns to Autorange and Auto is displayed.

3.7 DAR and PI

Sometimes an insulation part with obvious drawbacks (e.g., the insulation part is broken through under high voltage) is nevertheless with a good absorption ratio (or polarization index). Therefore, absorption ratio (polarization index) cannot be used to discover local insulation drawbacks other than dampness and contamination.

DAR and PI

Digital Multimeter

$$\text{DAR (absorbing ratio)} = \frac{\text{R 60 Sec}}{\text{R 15 Sec}}$$

$$\text{PI (polarization index)} = \frac{\text{R 10 Min}}{\text{R 1 Min}}$$

R10Min= Resistance value measured 10 minutes after applying the test voltage; R1Min=R60Sec= Resistance value measured 10 minutes after applying the test voltage; R15Sec= Resistance value measured 10 minutes after applying the test voltage After performed insulation test, press DAR/PI button, meter display DAR; press DAR/PI button again, meter display PI. If DAR or PI Value invalid, the meter display - - - .

3.8 Insulation Test Lock

In insulation test mode, press Test button to perform insulation test until the button is released. when the button is released, the screen display hold sign.

Press Lock Button, then the screen display Lock sign, press Test Button, the meter will perform insulation test until you press Test button again; The test lock will be unlocked while to cancel insulation test.

3.9 Timer Function for insulation

- Timer function is only valid in insulation test.
- In Init-Insulation status (Init-Insulation status is the rotary switch to Insulation position or have performed insulation test), press MEM button longer than 2S, the secondary screen display the remain key time, and primary screen display the 'CLOC'

Digital Multimeter



- When the remain key time is zero (as follow figure), Release MEM button



- The meter enter timer set-up status, the secondary screen display the preset time



- Press MEM button to change position, press shift button to change value



- Press HOLD button will save measuring time, and exit the assign status.
- When the measuring time is greater than zero and the test lock is unlocked, meter will activate the timer function, the meter will be automatically stop the test when the

Digital Multimeter

time is longer than preset time.

Note: Press Test button and turn on the meter, the meter display OFF^{SEC} and the timer function will be invalid..

- When the timer function is active, secondary screen display the output voltage, and alternately turn on or off 'SEC'



- Press shift button, the secondary screen display the measuring time and alternately turn on or off 'VDC'

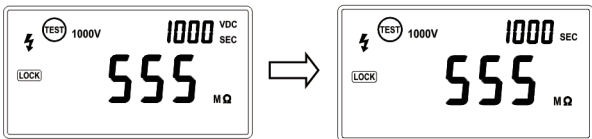

- Press test button to stop insulation test.

3.10 Data Recording

Data Recording in multimeter mode

- Press MEM button to enter recording status, the meter display 'MEM' as follows: In recording status, meter record the measuring value (when the record exceed 100 counts, the meter only record the last 100 counts) .



Digital Multimeter

- In recording status, press MEM button in succession, the meter will display the Max value, Min value, and Avg value.



- In recording status (or when the meter display Max. Min value), press MEM button longer than 1S, the meter will exit recording status.
- When meter display avg value as follows:



- Press MEM button longer than 1S, the secondary screen display the remain key time .

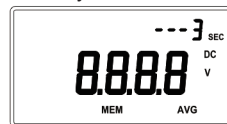

- When the remain key time is zero, the secondary screen display the counts of the recorded value as follows

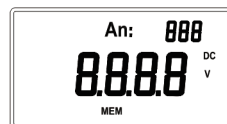

Digital Multimeter

- Press MEM button ,the secondary screen display the sequence number of the recorded value and the Primary display corresponding value.

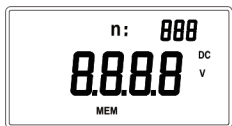

- Press MEM button to page down,and press Shift button to page up; press MEM button longer than 1S,then the secondary screen display the key remain time.when the key remain time is zero,the meter will be back to Record status.

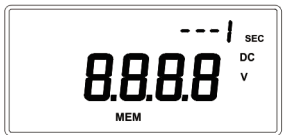

- When the key remain time is zero,the meter will be back to Record status.



Digital Multimeter

- Data Recording in insulation test mode
- In insulation test mode, the recording function will be activated, press MEM button to view the recorded value, the detailed operation is the same as data-recording in multimeter mode.

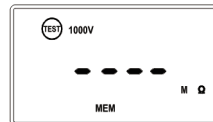

Digital Multimeter

4. Making Basic Measurements

4.1 Measuring DC Voltage

- Switch rotary switch to $\overline{\text{V}}$ Position, Input terminals and test leads connecting as follows figure, then connect test leads to circuit.
- mV Range in AutoRanging is Invalid.

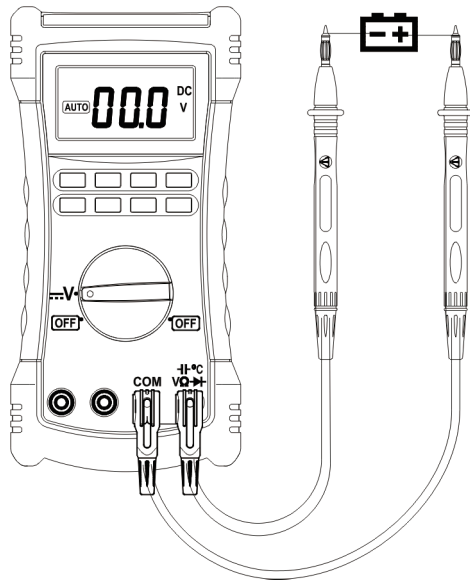

Digital Multimeter

4.2 Measuring AC Voltage

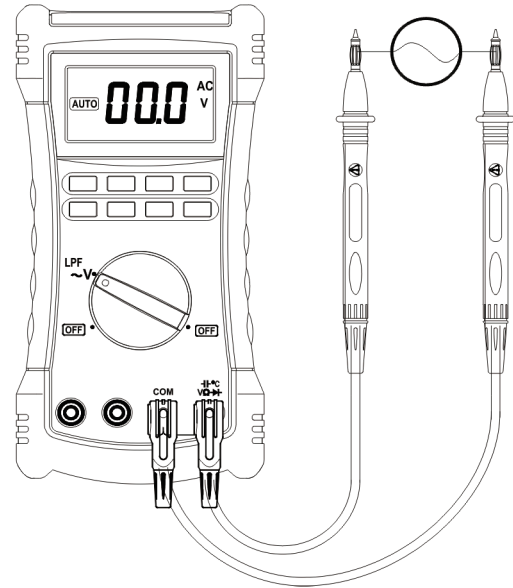

Digital Multimeter

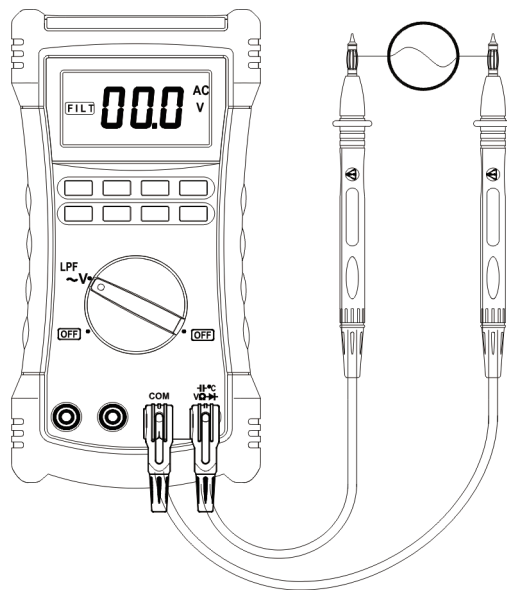

Digital Multimeter

True RMS Meters accurately measure distorted waveforms, but when the input leads are shorted together in the AC functions, the Meter displays a residual reading between 1 and 30 counts. When the test leads are open, the display readings may fluctuate due to interference. These offset readings are normal. They do not affect the Meter's ac measurement accuracy over the specified measurement ranges.

In AC Voltage measuring Mode to activated Low passed filter, the signal diverts through a filter that blocks unwanted frequencies above 1K Hz. To activated this funtion ,press shift button,the screen display **FILT** , to cancel low passed filter function ,press **Shift** button again ;

To avoid possible electric shock or personal injury, do not use the Low-Pass Filter function to verify the presence of hazardous voltages. Voltages greater than what is indicated may be present. First, make a voltage measurement without the filter to detect the possible presence of hazardous voltage. Then, select the filter function

4.3 Measuring Temperature

The Meter measures the temperature of a type-K thermocouple (included). Choose between degrees Celsius (°C) or degrees Fahrenheit (°F) by pressing **Shift** Button;

when the type-K thermocouple not connect to meter, the meter display the ambient temperature the Meter is rated for -30°C to 1300°C, the included K-type thermocouple is rated for 260°C. For temperatures out of that range, use a higher rated thermocouple.

To avoid risk of shock, do not connect thermocouple to electrically live circuits.

Digital Multimeter

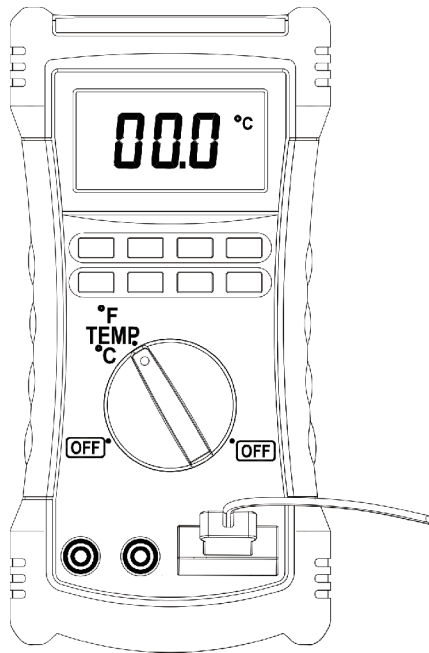

23

Digital Multimeter

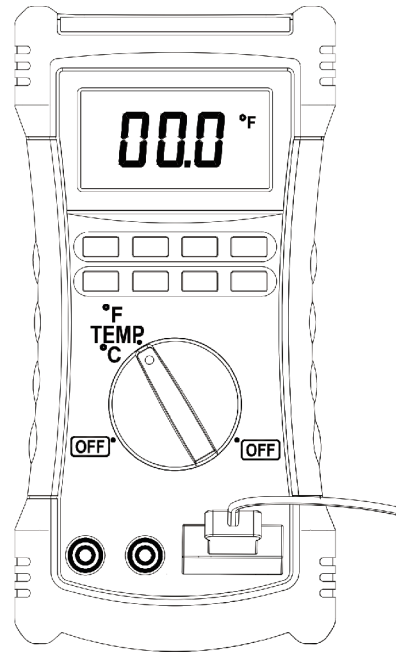

24

Digital Multimeter

4.4 Measuring Resistance and Measuring Capacitance

To avoid possible damage to the Meter or to the equipment under test, disconnect circuit power and discharge all high voltage capacitors before testing for continuity. Press **Shift** button switch between Measuring Resistance and Measuring Capacitance

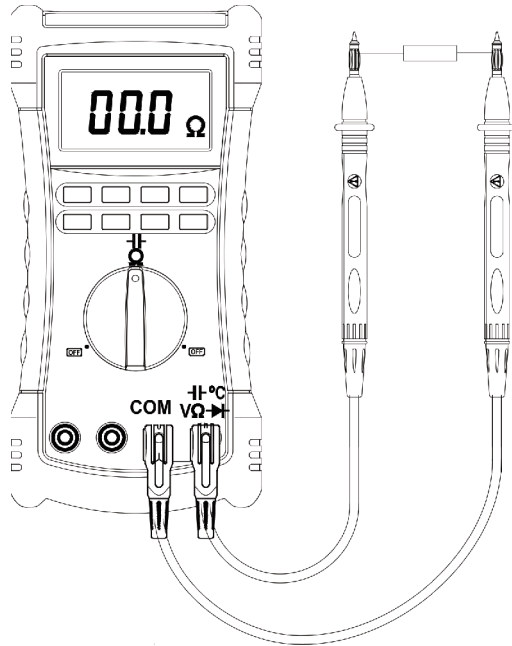

25

Digital Multimeter

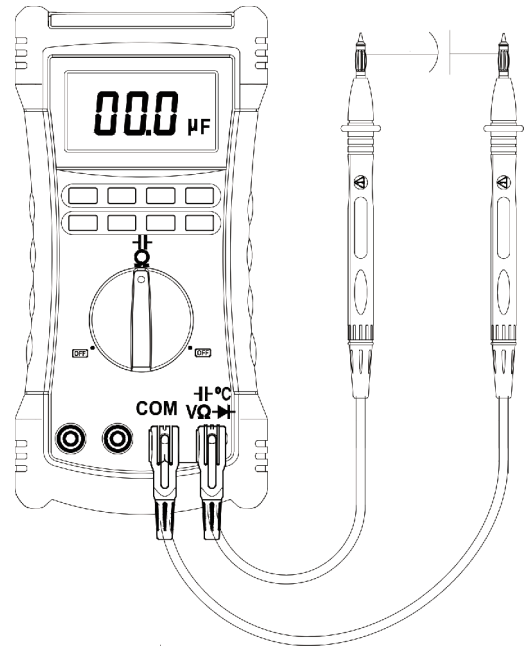

26

Digital Multimeter

4.5 Measuring Continuity and Measuring Diode

The continuity test and diode test features a beeper that sounds as long as a circuit is complete. The beeper sounds when a short ($<30\ \Omega$) or forward voltage lower than 300mV .

Press **Shift** button switch between Measuring Continuity and Measuring Diode.

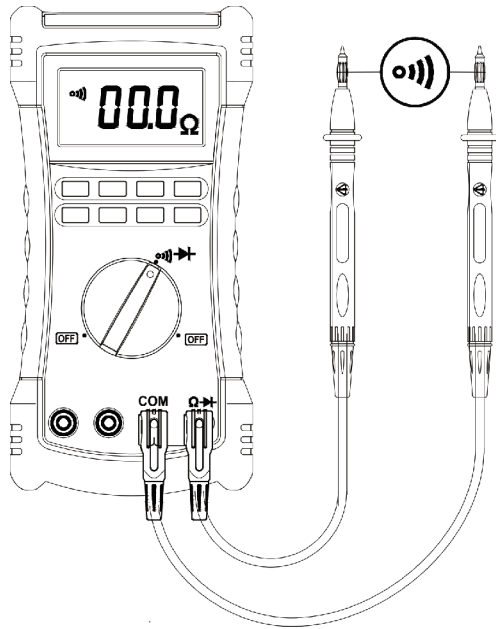

27

Digital Multimeter

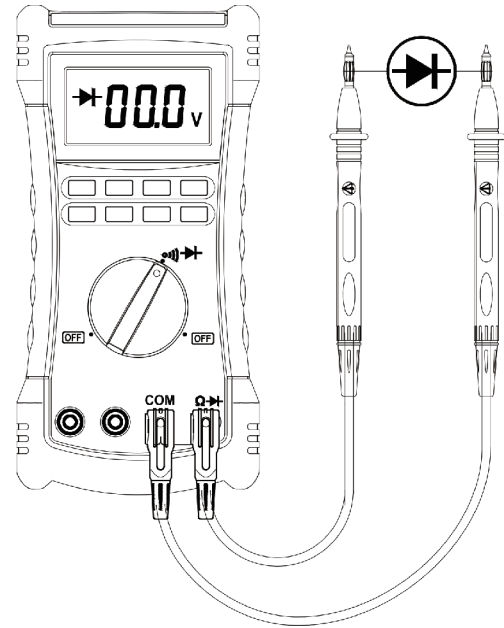

28

Digital Multimeter

4.6 Measuring AC or DC Current

- Check fuse is good before Test;
- Select proper input terminal, rotary switch, range ; not to measuring the current exceed the meter current rating (400mA)
- Turn power OFF to the circuit under test, break circuit, insert Meter in series, then turn power on
- Press Shift button switch between Measuring DC Current and Measuring AC Current.

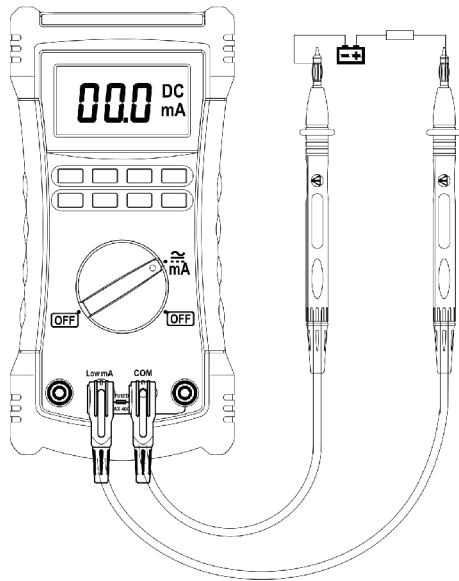

29

Digital Multimeter

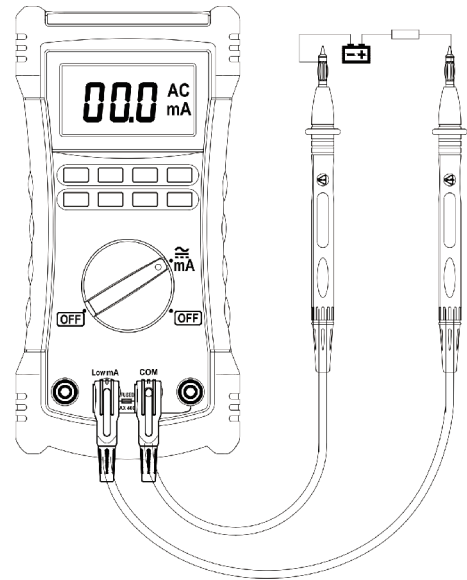

30

Digital Multimeter

4.7 Measuring frequency

In Measuring AC Voltage mode, Press Hz button Longer than 1S, the meter switch measuring voltage to frequency In Frequency mode, the Range button is invalid. press Hz button, the meter will switch to measuring AC Voltage.

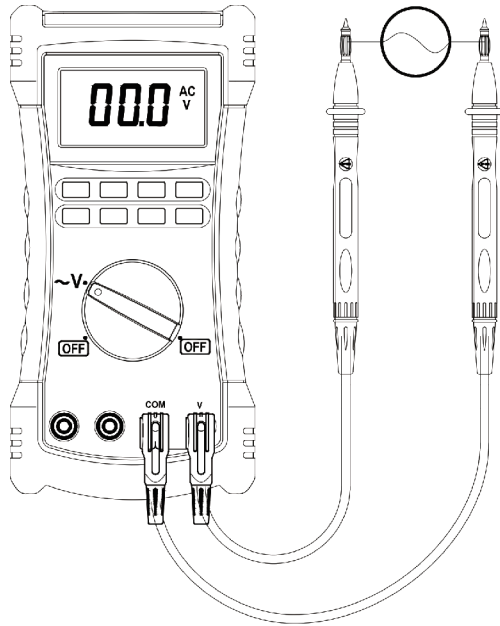

31

Digital Multimeter

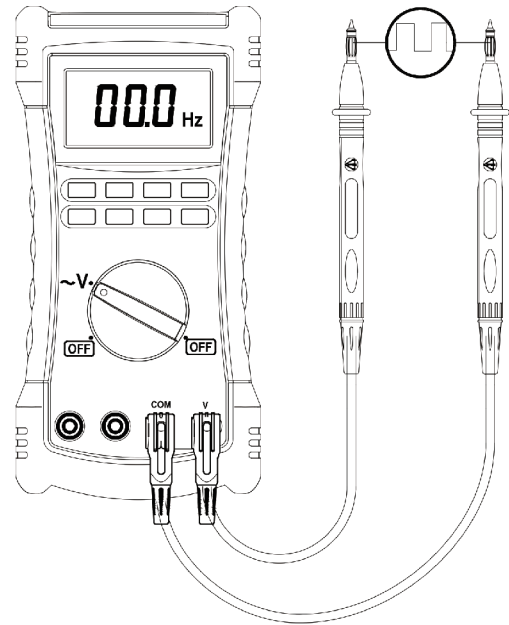

32

Digital Multimeter

4.8 Insulation Test

- Insulation tests should only be performed on dead circuits. Check the fuse and test leads before testing.
- Switch rotary to Insulation position. if meter display ⊕ , please recharge battery.
- Insert test leads to High/Low terminals. if the meter display Live and ⚡ , indicate the meter cannot measure on live circuit. please power off Live circuit..
- Press Range button to select output voltage;
- Press test button to perform insulation test, when the source voltage outputed the screen display ⚡ .
- In insulation measuring ,the screen alternate turn ⊕ TEST on or off, the primary screen display the resistance value, and the secondary screen display the Output voltage. Release the test button then discharges through the Meter, the meter display DISC.
- The secondary Display 0 VDC indicator when the voltage discharge finished.
- Disconnect the test leads from circuit..
- Active smoothing function by press Shift button ,the meter display Ⓢ .

Digital Multimeter

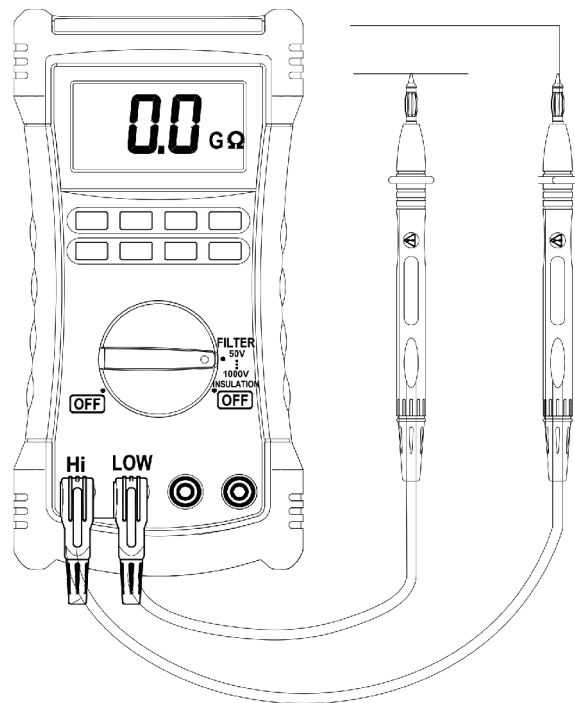

Digital Multimeter

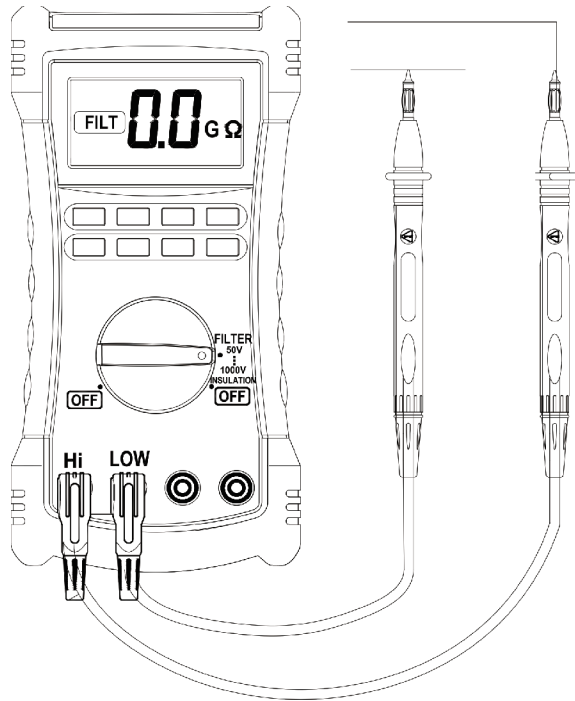

35

Digital Multimeter

5. General Specifications

- Complies with IEC/EN 61010-1 1000V CAT III, 600 V CAT IV.
- 1000V DC Voltage, 750VAC Voltage (TRMS) .
- 6600 Count (except for capacitance, temperature, insulation) .
- When the input terminals is V and COM, The overload protective voltage is up to AC 250 V (TRMS) ; When the input terminals is mA and COM, protective Current is 0.4A; when the input terminals is Hi and Lo, The overload protective voltage is 600V.
- Batteries: Four AA batteries (NEDA 15A or IEC LR6) Meter use 1000 hours; Insulation test use: Meter can perform at least 1000 insulation tests with fresh alkaline batteries at room temperature. These are standard tests of 1000 V into 1 MΩ with a duty cycle of 5 seconds on and 25 seconds off.
- Insulation Measurement Range: 0.01 MΩ to 2 GΩ.
- Insulation Test Voltages: 50V, 100V, 250V, 500V, 1000V .
- Insulation Source Voltage: + 20%, - 0% .
- Insulation Short-Circuit Test Current : 1 .5mA nominal.
- Insulation Auto Discharge : Discharge time <1 second for C = 1μF or less.
- Insulation Live Circuit Detection : Inhibit test if terminal voltage > 20V prior to initialization of test.
- Insulation Maximum Capacitive Load: Operable with up to 1μF load.
- Storage Temperature : -40 °C to 60 °C .
- Operating Temperature: 0°C to 40 °C .
- Storage Altitude: 12000m
- Operating Altitude: 2000m 1000V CAT III, 3000m 1000V CAT II
- Temperature Coefficient: 0.05 × (specified accuracy) per

36

Digital Multimeter

°C for temperatures < 18 °C or > 28 °C.

- Relative Humidity: 40%~75%.
- Size: 205(L)×102(W)× 58(H)mm.
- Weight: approx 390g.

6. Accuracy

6.1 DC Voltage

| Range | Resolution | Accuracy |
|-------|------------|-------------|
| 660mV | 0.1mV | ±(0.5% + 5) |
| 6.6V | 1mV | ±(0.5% + 5) |
| 66V | 10mV | ±(0.5% + 5) |
| 660V | 100mV | ±(0.5% + 5) |
| 1000V | 1V | ±(0.5% + 5) |

6.2 AC Voltage

| Range | Resolution | Accuracy |
|-------|------------|--------------|
| 660mV | 0.1mV | ----- |
| 6.6V | 1mV | ±(1.5% + 30) |
| 66V | 10mV | ±(1.5% + 30) |
| 660V | 100mV | ±(1.5% + 30) |
| 750V | 1V | ±(1.5% + 30) |

6.3 Temperature

| Range | Resolution | Accuracy |
|--------------|------------|-------------|
| -30°C~1300°C | 1°C | ±(1.0% + 2) |
| -22°F~2372°F | 1°F | ±(1.0% + 4) |

Accuracies apply following 90 minutes settling time after a change in the ambient temperature of the instrument.

Digital Multimeter

6.4 Resistance

| Range | Resolution | Accuracy |
|-------|------------|--------------|
| 660Ω | 0.1Ω | ±(1.2% + 5) |
| 6.6KΩ | 1Ω | ±(1.2% + 5) |
| 66KΩ | 10Ω | ±(1.2% + 5) |
| 660KΩ | 100Ω | ±(1.2% + 5) |
| 6.6MΩ | 1KΩ | ±(2.0% + 20) |
| 66MΩ | 10KΩ | ±(2.0% + 20) |

6.5 Capacitance

| Range | Resolution | Accuracy |
|-------|------------|--------------|
| 66nF | 10pF | ±(5.0% + 20) |
| 660nF | 0.1nF | ±(5.0% + 20) |
| 6.6μF | 1nF | ±(5.0% + 20) |
| 66μF | 10nF | ±(5.0% + 20) |
| 660μF | 0.1μF | ±(5.0% + 20) |
| 6.6mF | 1μF | ±(5.0% + 20) |
| 66mF | 10μF | ±(5.0% + 20) |

6.6 DC Current

| Range | Resolution | Accuracy |
|-------|------------|-----------|
| 66mA | 0.01mA | ±(1% + 5) |
| 400mA | 0.1mA | ±(1% + 5) |

6.7 AC Current

| Range | Resolution | Accuracy |
|-------|------------|--------------|
| 66mA | 0.01mA | ±(1.5% + 30) |
| 400mA | 0.1mA | ±(1.5% + 30) |

Digital Multimeter

6.8 Frequency

| Range | Resolution | Accuracy |
|----------|------------|------------------|
| 660.0Hz | 0.1Hz | $\pm(1.5\% + 5)$ |
| 6.600kHz | 1Hz | $\pm(1.5\% + 5)$ |
| 66.00kHz | 10Hz | $\pm(1.5\% + 5)$ |
| >10kHz | | ----- |

6.9 Insulation

| Output Voltage | Display Range | Resolution | Accuracy |
|----------------|--------------------|----------------|----------------|
| 50V(0~20%) | 0~5M Ω | 0.01M Ω | $\pm(3\% + 5)$ |
| | 5~50M Ω | 0.1M Ω | $\pm(3\% + 5)$ |
| 100V(0~20%) | 0~5M Ω | 0.01M Ω | $\pm(3\% + 5)$ |
| | 5~50M Ω | 0.1M Ω | $\pm(3\% + 5)$ |
| | 50~100M Ω | 1M Ω | $\pm(3\% + 5)$ |
| 250V(0~20%) | 0~25M Ω | 0.1M Ω | $\pm(3\% + 5)$ |
| | 25~250M Ω | 1M Ω | $\pm(3\% + 5)$ |
| 500V(0~20%) | 0~50M Ω | 0.1M Ω | $\pm(3\% + 5)$ |
| | 50~500M Ω | 1M Ω | $\pm(3\% + 5)$ |
| 1000V(0~20%) | 0~50M Ω | 0.1M Ω | $\pm(3\% + 5)$ |
| | 50~500M Ω | 1M Ω | $\pm(3\% + 5)$ |
| | 0.5G~2.0G Ω | 0.1G Ω | $\pm(5\% + 5)$ |

7. Replacing battery and fuse

- Only qualified service personnel are required to repair it.
- To avoid false readings, which could lead to possible electric shock or personal injury, replace the batteries (4 x 1.5V AA batteries) as soon as the battery indicator appears.
- Use only fuses with the amperage interrupt voltage and speed ratings specified (F 400mA, 1000V).

Digital Multimeter

- Turn the rotary switch to OFF and remove the test leads from the terminals.

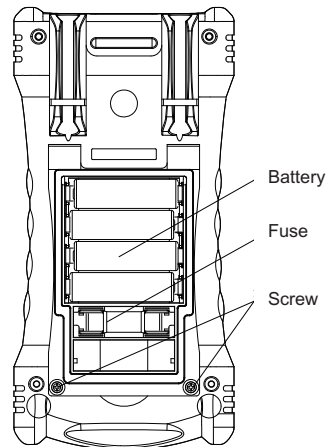

8. Accessories

| Item | Quantity |
|-----------------------|----------|
| Test Leads | 2 |
| Clips | 2 |
| K Type Thermocouple | 1 |
| Battery AA LR6 | 4 |
| Manual | 1 |
| Multi-Function Socket | 1 |