

3 PHASE DIGITAL POWER CLAMP METER

USERS MANUAL



CONTENTS

Safety Precautions	1
Safety Information	1
Safety Symbols	2
General Description	2
Feature	2
Meter Layout	4
Using The Selector	5
Using The Buttons	6
Lcd Display	9
Making Measurements	11
Measuring Ac Voltage	11
Measuring Ac Current	13
Measuring Single-Phase Circuit	15
Measuring Three -Phase Four-Wire Circuit	19
Measuring Three -Phase Three-Wire Circuit	24
Saving Measurement	24
Recalling Memory	24
RS232C Data Interface	25
Input Voltage And Current	26
Backlight Display	26
Sketch Of Safety Holding	26
Curve Diagram Of Power	27
Low Voltage Indication	28
Replacing Batteries	28
Specifications	29
Accessories	32

Safety Precautions

- Read these operation instructions thoroughly and completely before operating your meter. Pay particular attention to WARNING. The instructions in these warnings must be followed.
- You must be careful when working with voltages above 30V AC. Keep fingers behind the probe barriers while measuring.
- Never use the meter to measure voltages that might exceed the maximum allowable input value of any function measurement mode.
- Always inspect your meter and test leads before every use. If any abnormal conditions exist: broken test leads, cracked cases, LCD not reading, etc, do not attempt to take any measurement.
- Using the meter with the equipped test leads is only conform to safety requirements. If you need instead broken test leads, you must replaced with the same as type and electric specification.
- Never touch a voltage source when the test leads are plugged into a current jack.
- Do not expose the instrument to direct sunlight, extreme temperature or moisture.





WARNING

***READ THE INSTRUCTIONS BEFORE
USING THE INSTRUMENT***

Safety Information

Three-phase digital power clamp meter has been designed according to IEC1010-1 and IEC1010-2-032 concerning safety requirements for electrical measuring instruments and handheld clamps with pollution degree 2, overvoltage category (600V CATIII).

Safety Symbols

-  Important safety information, refer to the operating manual
-  Dangerous voltage may be present.
-  Earth ground
-  Double insulation (Protection class II)
-  Battery

General Description

Three-phase digital power clamp meter is a handheld aptitude meter with power measurement, it is incorporated current meter and power measurement instrument. The meter is composed of three channels: voltage, current, power and single chip Microcontroller. It has powerful measuring and data processing software, and complete to measure, calculate and display of the 8 parameters: Voltage, Current, Active Power, Power Factor, Apparent Power, Reactive Power, Active Energy, Frequency. It has Stable capability, easy operation. It is especially suitable for measurement and overhaul of the electric power equipment and the power-supply circuit on the spot. The structure of the instrument is pincers, it is very small, very light and portable, make measurement easy and fast. To the power measurement user, the digital power clamp meter which is used completely in three-phase system is one of the best instrument.

Feature

1. For power measurement of 3-phase 3-wire circuit, 3-phase 4-wire circuit, single-phase circuit.
2. The instrument can complete the true RMS value measurement. If there is nonsinusoidal AC current input signal, it can accurately measure the active current.

3. Using autorange switch circuit and modulus transducer which has 8000 count and high resolution, the instrument has high accuracy and easy operation.
4. Minimum current of Active Energy measurement is 0.5A, it can measure expending energy per hour of general electrical equipment. Measurement and display five parameters of power: Active Power, Apparent Power, Power Factor, Reactive Power, Active Energy.
5. Double display two parameters on each menu and store 28 groups of measurement parameter.
6. Measure five power parameters of each phase and total power value in three-phase measurement mode respectively.
7. Multifunctional button control, there are double scales analogue bar graph to display fluctuation of voltage and current.
8. With PC RS232C interface and special WINDOWS data graphics software.
9. Display measurement time and select tested voltage signal be power supply for the clamp at one time in Active Energy measurement mode, so the instrument can measure for long .
10. The instrument is a portable clamp meter. It is very light and convenient to carrying .

Meter Layout

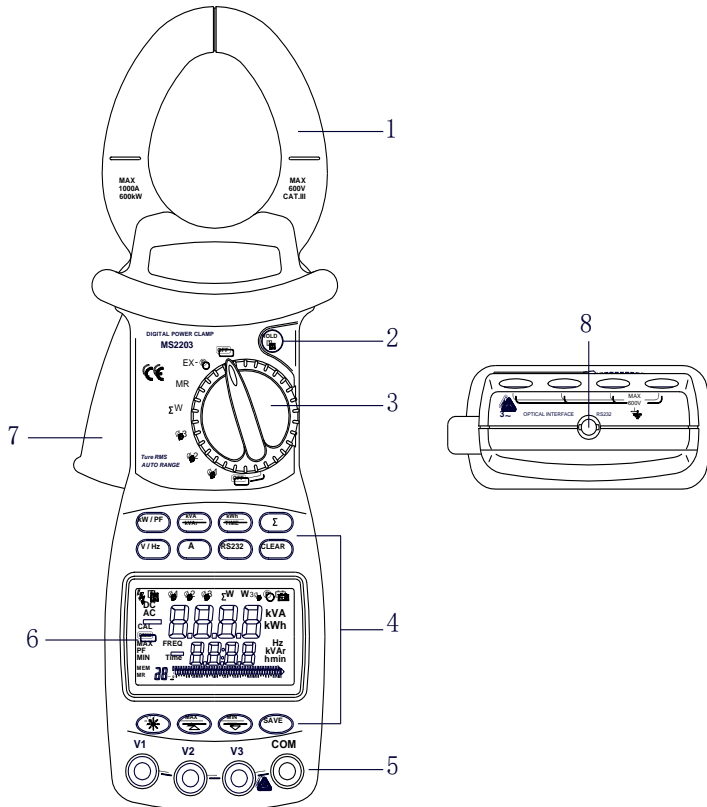

(Figure 1)

1. Clamp Jaws Φ 50mm
2. HOLD Button

Holds the display reading and "H" symbol is shown in the LCD display, press this button again, the meter return to normal measurement mode.

3. Function Selector Rotary Switch

Rotate the selector to any measurement function.

4. Function Selector Buttons

To select the measurement object.

5. Input terminal
 - V1: The input terminal for the first phase, using the yellow test lead to connect.
 - V2: The input terminal for the second phase, using the green test lead to connect.
 - V3: The input terminal for the third phase, using the red test lead to connect.
 - COM: Common terminal, the earth input terminal for all measurement modes, using the black test lead to connect.
6. LCD Display
 - 4 digits display, 7 segment LCD to display function mode, measured value and symbols.
7. Trigger
 - Press the lever to open the transformer. When the lever is released, the jaws will close again.
8. RS232C Data Interface
 - Your clamp meter can use a serial interface cable to communicate with a computer. Refer to Figure 18 for complete instructions.

Using the Selector

Turn the meter on by rotating the selector to any function as following .

(Table 1. Introducing The Selector)













ITEM	DESCRIPTION
OFF	POWER OFF. Turn the meter off
EX-Ⓟ	EXTERNAL POWER SUPPLY. No use battery, select tested voltage signal be power supply for Active Energy measurement for long at one time.
MR	RECALL DATA. Recall saved data in the meter memory.
ΣW	TOTAL POWER. For display total power value of three phase













(Table 1. Introducing The Selector)















ITEM	DESCRIPTION
$\Phi 3$	THIRD MEASUREMENT CHANNEL. For V3 input terminal measurement
$\Phi 2$	SECOND MEASUREMENT CHANNEL. For V2 input terminal measurement
$\Phi 1$	FIRST MEASUREMENT CHANNEL. For V1 input terminal measurement

Using the buttons

(Table 2. Function Button)

ITEM	DESCRIPTION
1	 Active Power, Power Factor Measurement Button.
2	 Apparent Power, Reactive Power Measurement Button.
3	 Active Energy, Time Measurement Button
4	 Power Summation Button
5	 Voltage, Frequency Measurement Button
6	 Current Measurement Button
7	 Data Transmit Button
8	 Clear Memory Button
9	 Backlight Button
10	 Maximum Value Button/ Previous Record Button
11	 Minimum Value Button/ Next Record Button
12	 Data Save Button

1.  Active Power, Power Factor Measurement Button
Press  button to measure Active Power and Power Factor in measurement mode. Then the LCD shows Active Power reading in the primary display and Power Factor reading in the secondary display.
2.  Apparent power, Reactive Power measurement button
Press  button to measure Apparent Power and Reactive Power in measurement mode. Then the LCD shows Apparent Power reading in the primary display and Reactive Power reading in the secondary display.
3.  Active Energy, Time Measurement Button
Press  button to measure Active Energy in measurement mode. Then the LCD shows Active Energy reading in the primary display and measurement time of the Active Energy in the secondary display.
4.  Power Summation Button
Press  button to sum up the measured value of current one phase in three phase measurement mode; then measure the second phase and press the  button to sum up again; press the  button for the third phase after you getting the measured value of the third phase on the display. So the meter will calculate the sum in this three phase system automatically, you will rotate the selector to ΣW at one time, then the display shows the total power value.
5.  Voltage Measurement Button
Press  button to measure voltage of the circuit and display the measured value in the LCD display.

6.  Current Measurement Button
Press  button to measure current of the circuit and display the measurement value in the LCD display.
7.  Data Transmit Button
Press  button to transmit measured data to a computer by special interface cable, you can record current measured value and print reports and data trend curve drawing.
Before press the  button to transmittal measured data, you must connect RS232C interface cable to the clamp meter and a computer. the communication function is working.
8.  Clear Memory Button
Press  button for three seconds to erase all measured data in the meter memory in the measurement mode.
9.  Backlight Button
Press  button to turn the backlight on or off. When the back-light turned on over five seconds, it will turn off automatically.
10.  Maximum Value Measurement Button / Previous Record Button
Press  button to measure maximum value in measurement mode. The display shows current maximum value in the secondary display.
When you turn the selector to MR, press  button to recall previous memory location and display the data on the LCD. Once pressing this button, the clamp meter recalls a memory location previous current location.
11.  Minimum Value Measurement Button / Next Record Button
Press  button to measure minimum value in measurement mode, the display shows current minimum value in the secondary display.

When you turn the selector to MR, press  button to recall next memory location and display the data on the LCD. Once pressing this button, the clamp meter recalls a memory location next current location.

12.  Data Save Button

Press  button to save current measured data to the meter in measured mode. The meter can save 28 groups of measured data into the meter at most.

Lcd Display

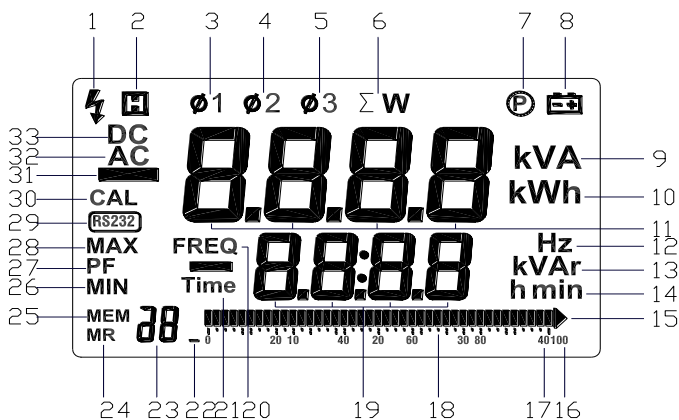

(Figure 2)

1. Dangerous voltage symbol
2. Data holding symbol
3. First phase symbol
4. Second phase symbol
5. Third phase symbol
6. Three phase total power symbol
7. External power supply symbol
8. Battery symbol

9. Voltage unit (V), current unit (A), Apparent Power unit (kVA)
(For primary display)
10. Active power unit (kW)、 Active Energy unit (kWh)
11. 4 digit display (For primary display)
12. Frequency unit
13. Voltage unit (V), current unit (A), Apparent Power unit (kVA),
Reactive Power unit (kVAr) (For secondary display)
14. Time unit : hour(h)、 minute(min)
15. Overflow symbol
16. 100 graduate scale
17. 40 graduate scale
18. Bar graph
19. 4 digit display (For secondary display)
20. Frequency unit
21. Time symbol
22. Negative sign of scale
23. Number of memory location symbol
24. Recall data symbol
25. Save data symbol
26. Minimum value symbol
27. Power factor symbol
28. Maximum value symbol
29. RS232C interface symbol
30. Calibrate symbol
31. Negative symbol
32. AC symbol
33. DC symbol

Making Measurements

✦ Measuring AC Voltage

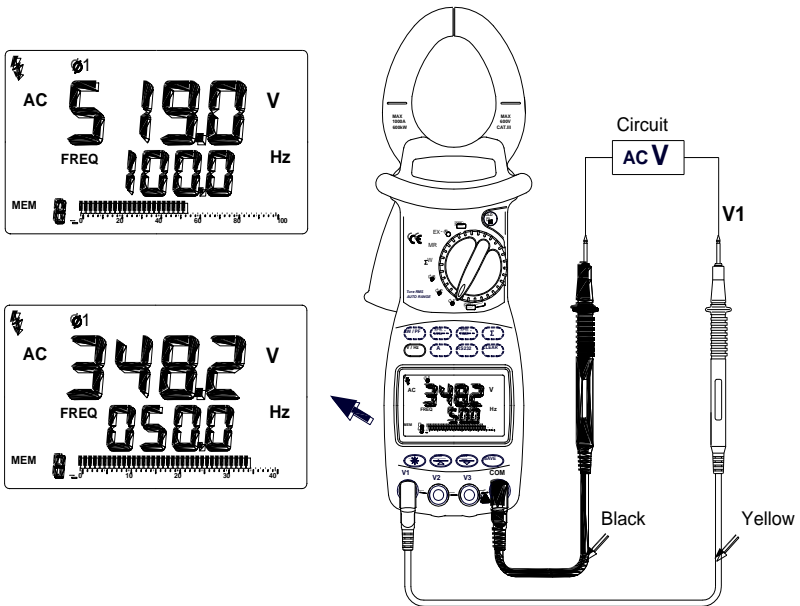





(Figure 3. Voltage Measurements)

1. Turn the selector to one of $\Phi 1, \Phi 2, \Phi 3$, refer to Table 3 to connect the test leads to input terminals: Insert the black test lead into the COM input terminal and one corresponding color test lead into the corresponding input terminal.(Figure 3)

(Table 3 Input Terminal Connections)

SELECTOR	INPUT TERMINAL (+)		INPUT TERMINAL (-)		Phase
$\Phi 1$	V1 jack	Yellow lead	COM jack	Black lead	First phase
$\Phi 2$	V2 jack	Green lead	COM jack	Black lead	Second phase
$\Phi 3$	V3 jack	Red lead	COM jack	Black lead	Third phase

2. Connect test leads to the load, press  button, voltage measured value is displayed in the primary display and current frequency value of voltage is shown in the secondary display.

3. In voltage measurement mode, press  button, the LCD displays "MAX" symbol, then maximum value(TRMS) is shown in the secondary display. Press  button again, the "MAX" symbol is disappeared, the secondary display return to current frequency value .
4. Press  button, the LCD displays "MIN" symbol, then minimum value(TRMS) is shown in the secondary display. Press  button again, the "MIN" symbol is disappeared, the secondary display return to current frequency value.
5. For input voltage exceeds 600V, the display will show "OL" symbol and the bar graph is full.(Figure 4)

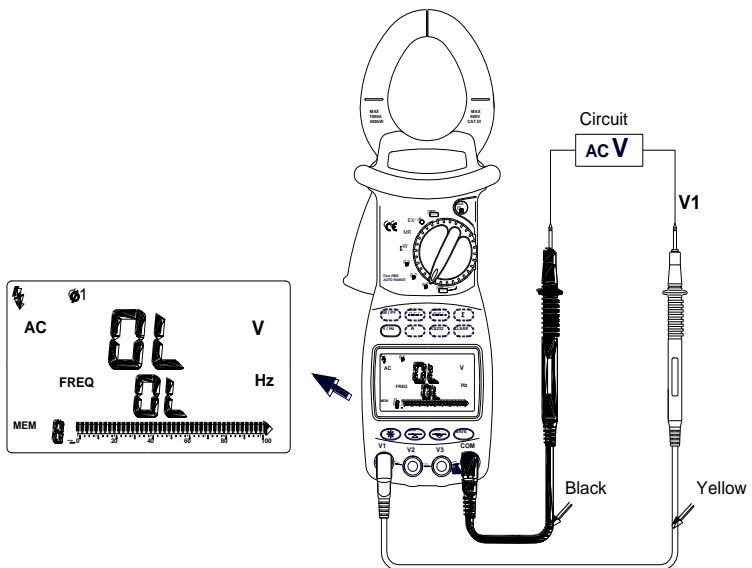

(Figure 4. Voltage Exceeds 600V)

6. For input voltage exceeds 30V, the display will show "⚡" for safety.
7. There are two modes to show the bar graph in the LCD. You can observe fluctuation range of measured voltage. The first mode is 0-20-40-60-80-100, the second is 0-10-20-30-40.

✦ Measuring AC Current

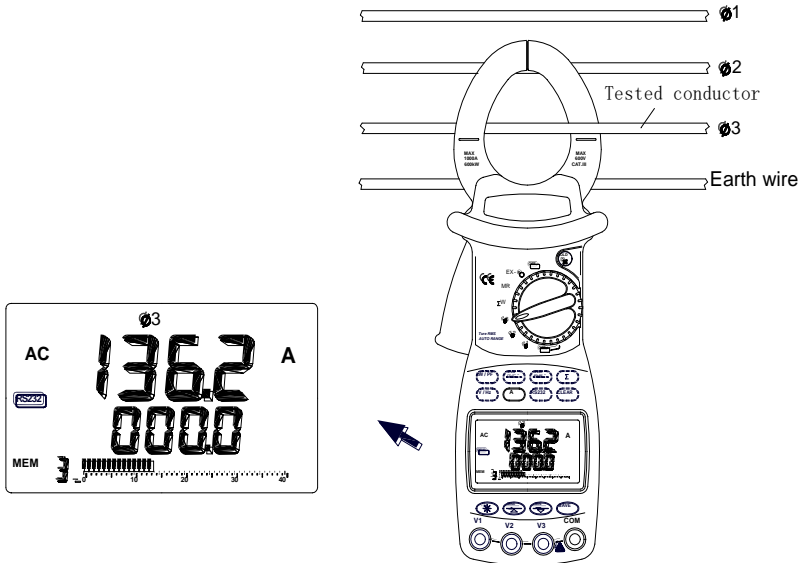

(Figure 5. Current Measurements)

1. Turn the selector to one of $\Phi 1, \Phi 2, \Phi 3$.
2. Press the trigger to hook the clamp jaw around one conductor to be measured. Press **A** button, the primary display reading is current value(RMS) of the conductor. (Figure 5)
3. To measure the maximum value of current, press **MAX** button, the maximum value is shown in the secondary display. Press **MAX** button again to cancel maximum value measurement. (Figure 6)
4. To measure the minimum value of current, press **MIN** button, the minimum value is shown in the secondary display. Press **MIN** button again to cancel minimum value measurement.
5. For current exceeds 1000A(RMS), the display will show "OL" symbol. (Figure 7)

6. There are two modes to show the bar graph. You can observe the fluctuation range of measured current. The first mode is 0-20-40-60-80-100, the second is 0-10-20-30-40.(Figure 5 and Figure 6)

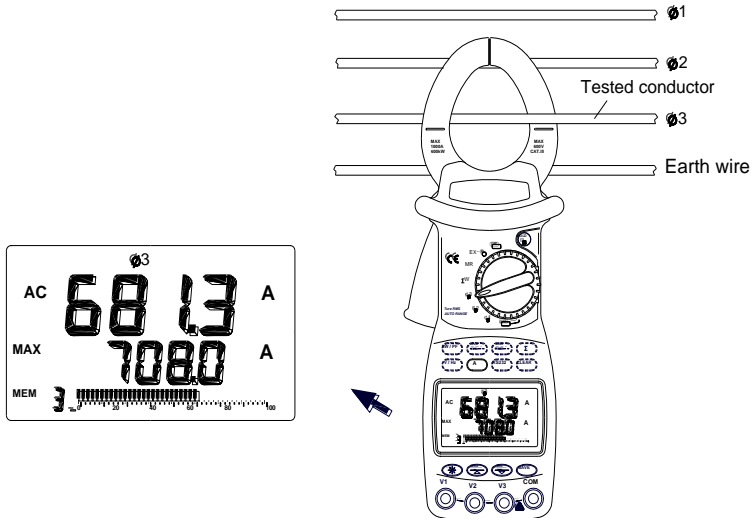

(Figure 6. Maximum Value Of Current Measurements)

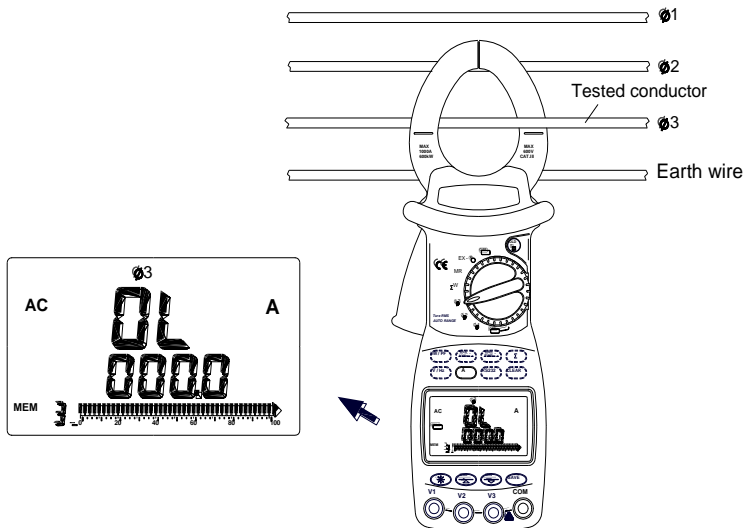

(Figure7. Current Exceeds 1000A)

✦ *Measuring Single-Phase Circuit*

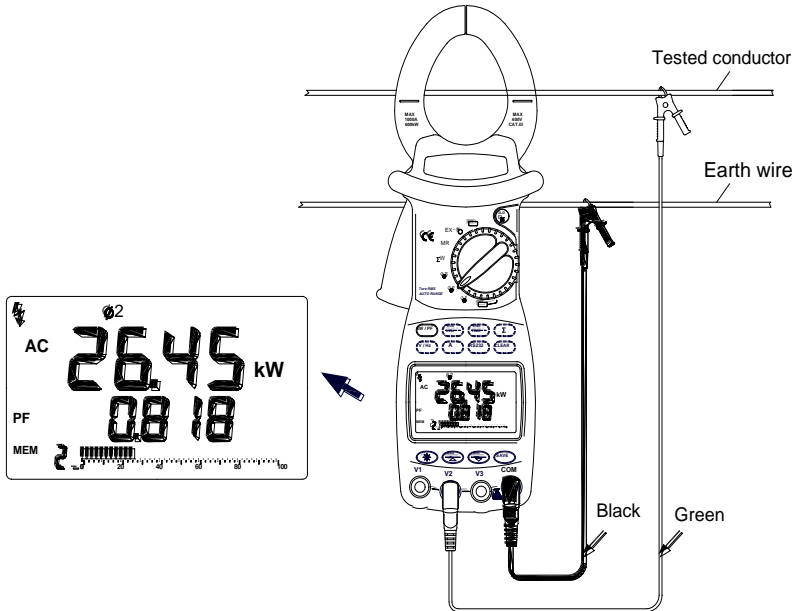



(Figure 8. Single-phase Power Measurements)

1. Hook the clamp jaws around the conductor of the loading or the circuit. The clamped conductor is one phase which you want to test in the three-phase circuit.
2. Turn the selector to one of $\Phi 1, \Phi 2, \Phi 3$, and refer to Table 3 to connect test leads into input terminals which is corresponding to the position of the selector. (Figure 8)
3. After right connection, you can measure five power parameters of single-phase circuit (Active Power, Power Factor, Apparent Power, Reactive Power, Active Energy):

(1.) Active Power(kW) and Power Factor (PF) (Figure 8)

- a. Press  button, the Active Power value is shown in the primary display and the Power Factor value, "PF" symbol are shown in the secondary display. When the Power Factor value is negative, the loading is capacitive.

- b. The maximum measurement range of Active Power is 600kW. For exceeding the maximum value, the “OL” symbol will be shown in the display. If test voltage exceeds 600V or the test current exceeds 1000A, the “OL” symbol will be shown in the display too. And the bar graph is full.(Figure 9) The minimum input voltage is 20V and the minimum input current is 5A, if it less than the minimum input voltage and minimum input current, the Active Power value is “0.00kW”.
- c. Press  button, the maximum value of Active Power is shown in the secondary display.
- d. Press  button, the minimum value of Active Power is shown in the secondary display. .
- e. The bar graph “0-20-40-60-80-100” is shown.

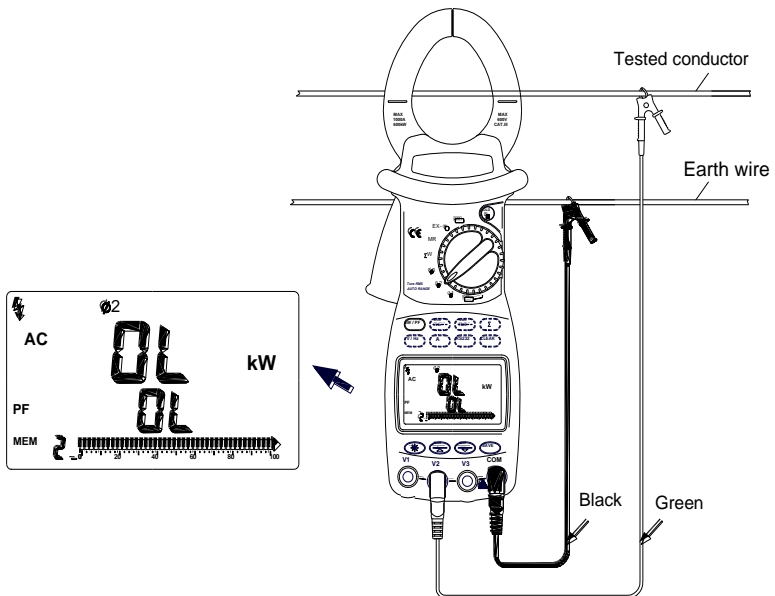



(Figure 9.Current Exceeds 1000A Or Voltage Exceeds 600V)

(2.) Apparent Power (kVA) and Reactive Power (kVAr)

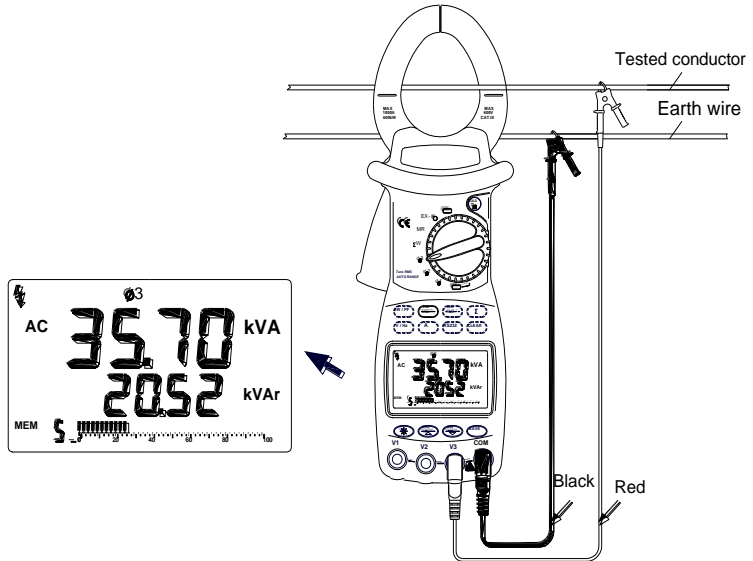
- a. Press  button, the Apparent Power value is shown in the primary display, Reactive Power value and the bar graph “0-20-40-60-80-100” are shown in the secondary display. (Figure 10)



(Figure 10. Apparent power measurements)

- b. For input voltage less than 20V and input current less than 5A, Apparent Power value is “0.00kVA”.
- c. Press  button, the maximum value of Apparent Power is shown in the secondary display.
- d. Press  button, the minimum value of Apparent Power is shown in the secondary display.
- e. Reactive Power is not direct measuring parameter of power, $kVA^2 = kW^2 + kVA^2$ is a formula to calculate Reactive Power value. The value is calculated and shown according to measured voltage, current and Active Power in software.

(3.) Active Energy (kWh) and Time (hmin)

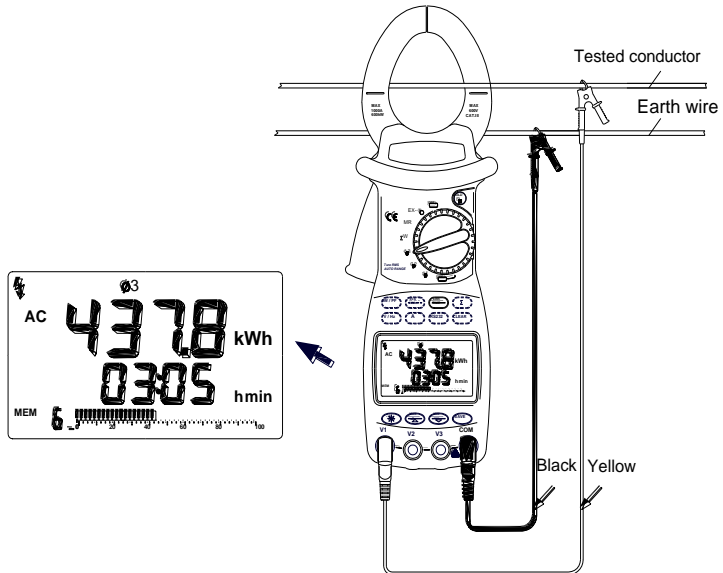

- a. In Active Energy measurement mode, voltage signal must be input into V1 and COM terminal of the clamp meter (Figure 11), and the selector must be turned to $\Phi 1$. So the Active Energy measurement function is valid,



(Figure11. Active Energy measurements)

- b. Press  button, starting value of the Active Energy is “0.000kWh” and is shown in the primary display at first, Active Energy measured time and the bar graph “0-20-40-60-80-100” is shown in the secondary display. For the time is longer, the measured value of Active Energy is larger. If you need read the Active Energy value sometime, press the HOLD button, so the measured value display and the display of the measured time are locked, but the Active Energy measurement is continuing and timing in the clamp meter. After reading the display, press HOLD button again to exit date hold

and continue to measure, Active Energy value still add up. Active energy measurement don't stop until select other measurement function.

- c. The  button and  button is invalid in Active Energy measurement mode.
- d. The maximum value of Active Energy is "9999kWh". If Active Energy value exceeds the maximum value , the display will show "OL" symbol.
- e. Active energy measurement is viable in single-phase circuit because you only measure current of one phase at one time, so you can not measure three-phase Active Energy. If you need measure Active Energy for long during measurement, you are suggested that you can use EX- function, the meter will work no using the battery but test voltage signal as power supply.

NOTE: When you turn the selector to EX- to measure voltage or power parameter, the input voltage of V1 jack must less than 250V, otherwise the fuse will be blown.

✦ *Measuring Three –Phase Four-Wire Circuit*

Three-phase power parameter means total Active Power, total Reactive Power, total Apparent Power, total Power Factor. The clamp meter can not measure three-phase Active Energy. The measurement method of three-phase power parameter is that you measure power parameter of each phase conductor respectively at first, then calculate three-phase power parameter in the meter. For a balance load, the measured data is accurate, if power parameter fluctuates larger, then the error of total power parameter increases more.

1. Refer to Table 3, connect yellow test lead, green test lead, red test lead to every phase live wire of the three-phase circuit and V1 jack, V2 jack, V3 jack of the meter respectively, connect black test lead to zero conductor of the circuit and COM jack of the meter.
2. Turn the selector to $\Phi 1$ at first (to first phase measurement), hook the clamp jaw around the first phase conductor of the tested circuit, press **kw / PF** button to measure Active Power (kW) and Power Factor (PF). the measured value are shown in the LCD then press **Σ** button to sum power parameter of this phase; press **$\frac{kVA}{kVAR}$** button again to measure Apparent Power and Reactive Power, after the result is shown in the LCD, press **Σ** button to sum power parameter of this phase. So power parameter measurement is completed in the first phase. If you need save the result, you can press **SAVE** button to do it. (Figure 12)

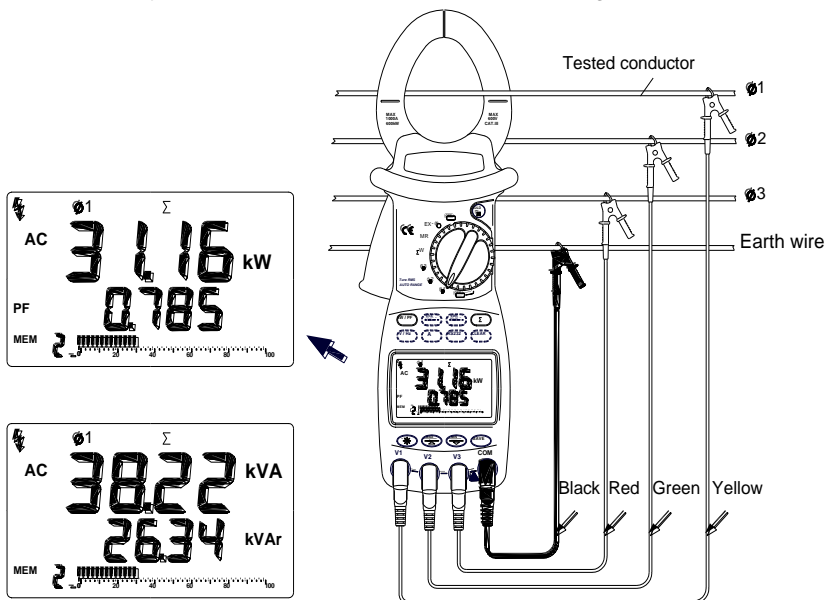

(Figure 12.The First Phase Power Measurements)

3. Turn the selector to $\Phi 2$ (to the second phase measurement), hook the clamp jaw around the second phase conductor of the tested circuit, press **kW / PF** button and **kVA / kVA_r** button to measure power parameter respectively, when measured result is shown every time, you must press Σ button to sum in turn. The operation is same as the first phase measurement. (Figure 13)
4. Turn the selector to $\Phi 3$ (to the third phase measurement),hook the clamp jaw around the third phase conductor of the tested circuit, press **kW / PF** button and **kVA / kVA_r** button to measure power parameter respectively, when measured result is shown every time, you must press Σ button to sum in turn. The operation is same as the first phase measurement. (Figure 14)

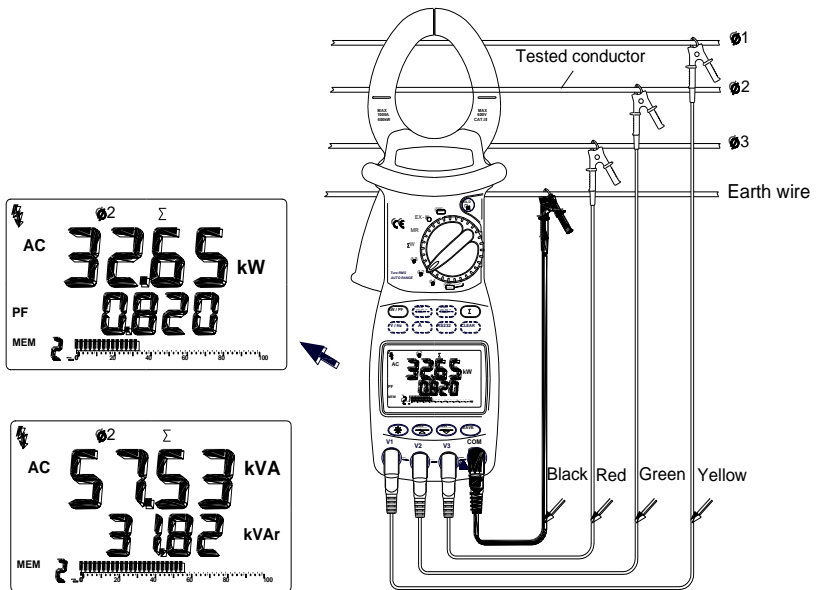

(Figure 13.The Second Power Measurements)

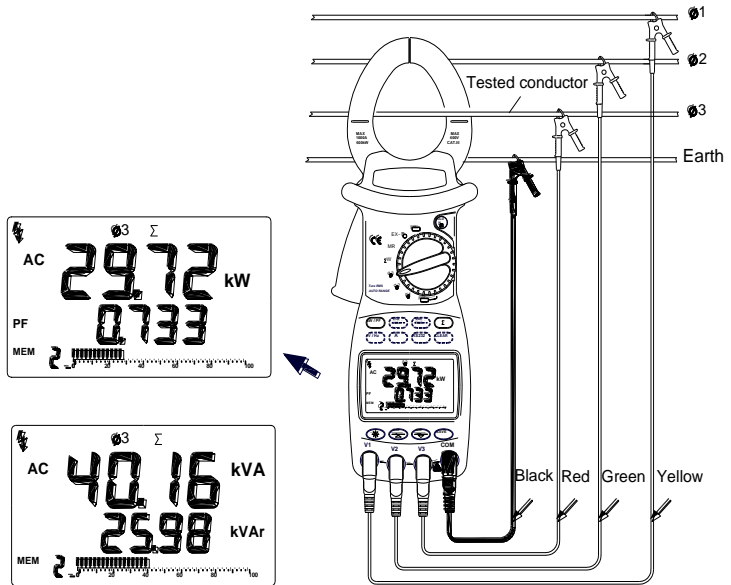

(Figure 14. The Third Phase Power Measurements)

5. After above every phase measurement, turn the selector to ΣW , then the display shows total Active Power value and Power Factor value of the three-phase load (Figure 15). After display for three seconds, the display switches to show total Apparent Power value and total Reactive Power value automatically(Figure 16). The total Apparent Power value is in the primary display and the total Reactive Power value is in the secondary display. The display switches automatically every three seconds until you turn the meter to other function.

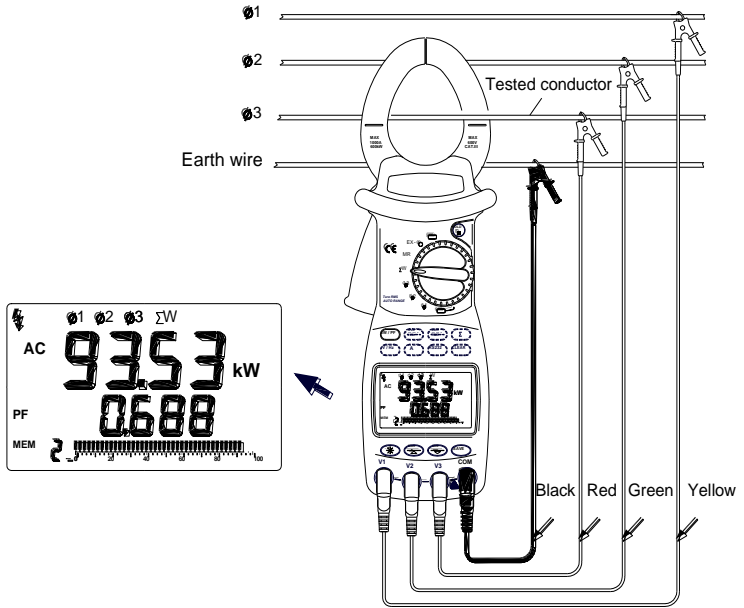

(Figure15. Total Active Power Of Three-Phase)

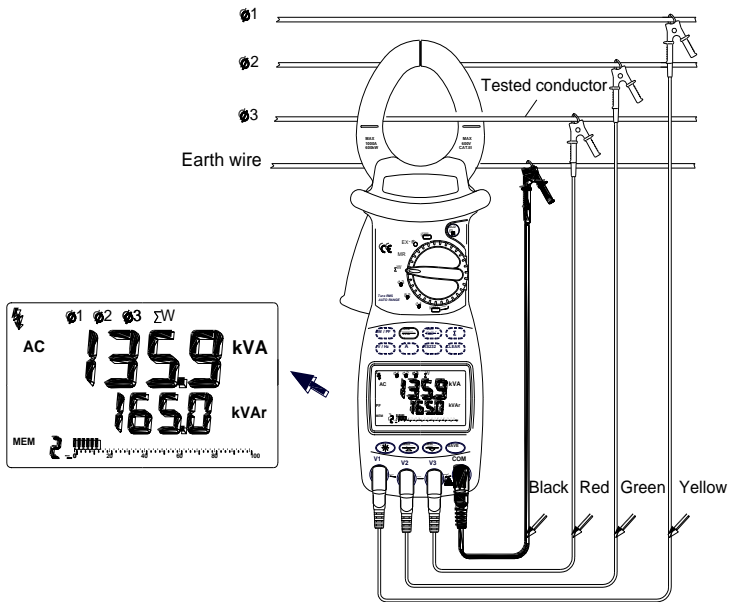

(Figure16. Total Apparent Power Of Three-Phase)

✦ **Measuring Three-Phase Three-Wire Circuit**

In three-phase three-wire circuit, the operation of the selector and function button is same as the operation in three-phase four-wire circuit except the connection of test leads.(Figure 17)

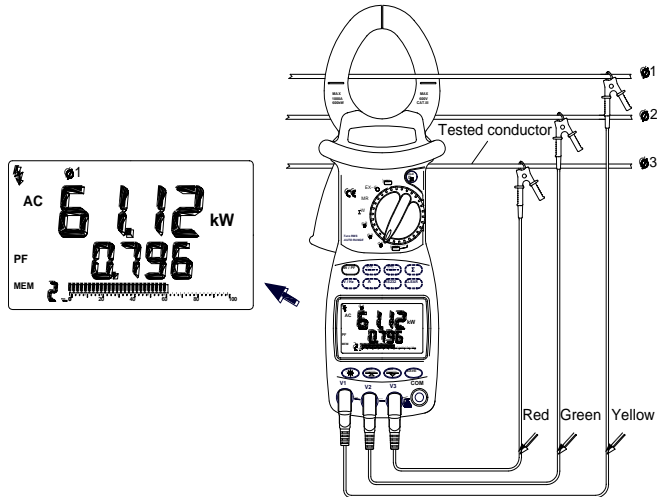

(Figure 17.Power Measurements Of Three-Phase Three-Wire)

✦ **Saving Measurement**



In measurement mode, you can press **SAVE** button to save the present display to a memory location. The meter can store 28 groups of measurement date.

When the meter has saved 28 groups of date, you press **SAVE** button to save again, the display shows “FUL” symbol to prompt full memory in the meter now. You must press **CLEAR** button to clear the memory and continue saving new date.

✦ **Recalling Memory**

If something is saved in the meter memory, use following procedure to display of a memory location:

1. Turn the selector to MR.

2. The display shows “MR” and “HOLD” symbol, location number and date in current memory location.
3. Press  button and  button to cycle through memory location.

✦ **RS232C Data Interface**

Connect RS232C interface cable to the clamp meter as shown in Figure 18, then rotate the interface cable deasil to lock it in the meter. Connect the other plug of the interface cable to a serial port of a computer. Then the meter can transmit measured data to computer by the infrared photoelectricity RS232C interface in real-time mode. If you want to take out the interface cable from the meter, first you must rotate the cable widdershins to unlock it, then you can pull out it . You will install the special data record software into the computer according to README.TEXT file in SETUP disk. When the meter is in measurement mode, press  button, you can record and print the measured data of the meter in real time mode in the WINDOWS. The software can record, plot, print data and curve.

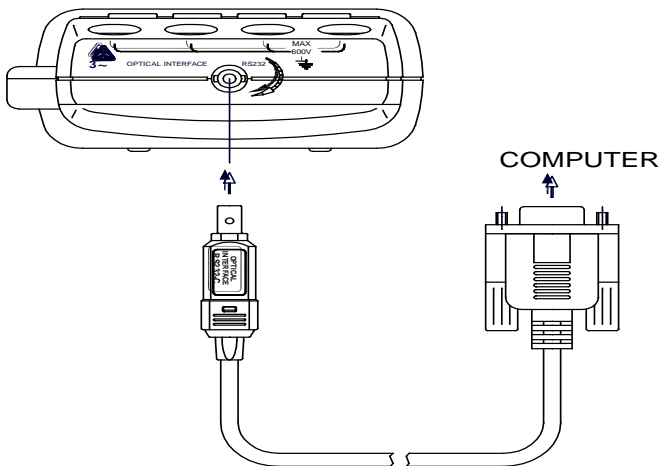

(Figure 18. RS232C Interface Cable Connection)

✦ ***Input Voltage And Current***

When the meter is in power measurement mode, if input voltage exceeds 600V(TRMS)or current exceeds 1000A (TRMS), the meter will display “OL” symbol, and bar graph is full. When input voltage exceeds 30V, the “ ⚡ ” symbol is shown in the display for safety.

✦ ***Backlight Display***

When press  button, backlight of LCD display is on. After lighting for 4 seconds the backlight is self-off.

✦ ***Sketch Of Safety Holding***

Use the wrist-webbing to prevent a accidentally drop as shown in Figure 19.

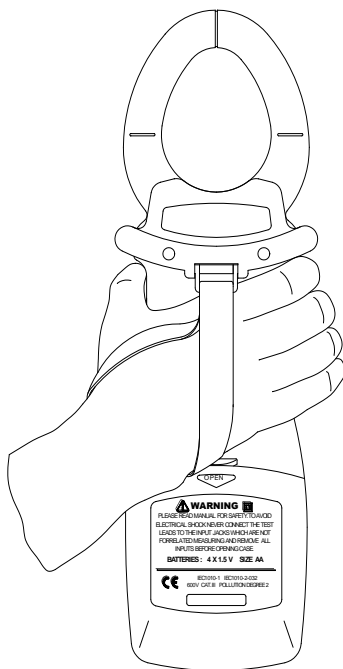

(Figure 19)

★ **Curve Diagram Of Power** (PF=KW / KVA)

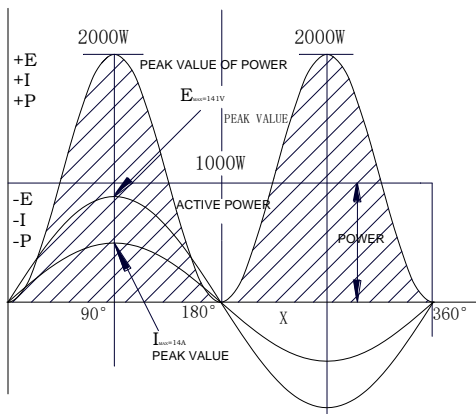

(Figure 20. PF=1)

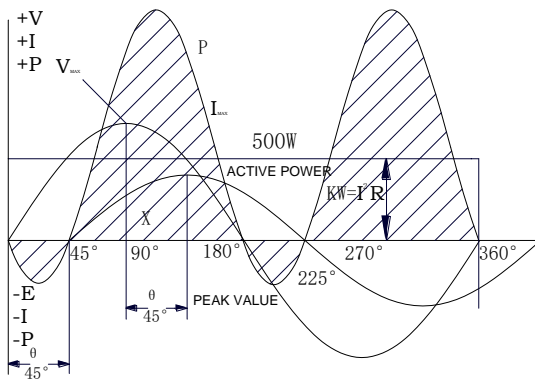

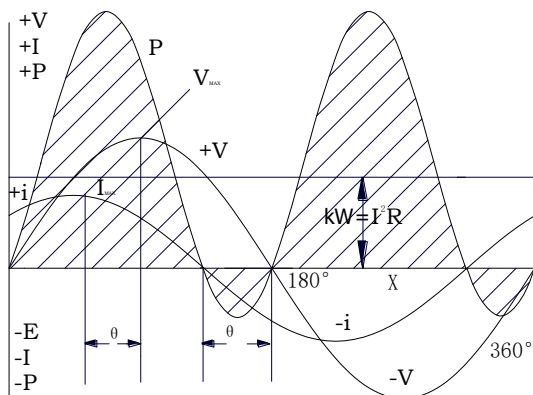

(Figure 21)



(Figure 22)

✦ **Low Voltage Indication**

The "  " symbol is shown on the top right of the LCD display, when the batteries is weak, you need replace new batteries or use the EX- function of the meter now. Turn the selector to EX-, the meter use the measured voltage signal as power supply to work. But the meter only measure single-phase circuit and can not work in three-phase circuit in this power source mode.

Replacing Batteries



WARNING

To avoid electrical shock , the instrument must be power off and disconnect the test leads or any input signals before replacing the batteries. Never use the instrument unless the back cover of the instrument is fastened completely. Replace only with same type or rating batteries.

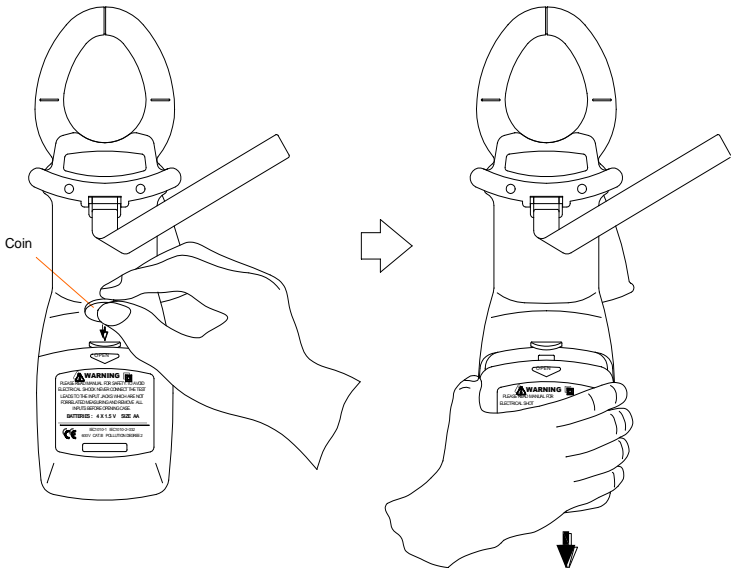

(Figure 23. Open The Battery Cover)

When the LCD displays the “” symbol, the batteries must be replaced to maintain proper operation. Use the following procedure to replace the batteries:

1. Disconnect test leads from any signals, turn the rotary function switch to OFF, and remove the test leads from the input terminals.
2. Open the battery cover and remove the battery cover. Because there is a locked design in the battery cover. Don't force the battery cover open, otherwise the cover is broken. Refer to Figure 23 for opening it: Insert a coin into the groove of the battery cover, press the coin down, then open the cover.
3. Remove batteries and replace with new batteries which is the same type or rating.
4. Reinstall the battery cover.

SPECIFICATIONS

AC VOLTAGE			RMS
RANGE	ACCURACY	RESOLUTION	INPUT IMPEDANCE
100V	$\pm(1.2\%+5)$	0.1V	10 M Ω (10Pf SHUNT)
300V	$\pm(1.2\%+5)$	0.1V	
600V	$\pm(1.2\%+5)$	0.1V	

Max. Overload Voltage: 750V (RMS)

AC CURRENT		RMS
RANGE	ACCURACY	RESOLUTION
40A	$\pm(2\%+5)$	0.1A
100A	$\pm(2\%+5)$	0.1A
400A	$\pm(2\%+5)$	0.1A
1000A	$\pm(2\%+5)$	0.1A

Max. Overload Current: 1500A

ACTIVE POWER		(W)
RANGE	ACCURACY	RESOLUTION
4kW	$\pm(3\%+5)$	0.01kW
10kW	$\pm(3\%+5)$	0.01kW
40kW	$\pm(3\%+5)$	0.01kW
100kW	$\pm(3\%+5)$	0.01kW
600kW	$\pm(3\%+5)$	0.1kW

Minimum measurement current : 5A

Minimum measurement voltage : 20V

APPARENT POWER		(VA)
RANGE	ACCURACY	RESOLUTION
4kVA	$\pm(3\%+5)$	0.01kVA
10kVA	$\pm(3\%+5)$	0.01kVA
40kVA	$\pm(3\%+5)$	0.01kVA
100kVA	$\pm(3\%+5)$	0.01kVA
600kVA	$\pm(3\%+5)$	0.1kVA

Minimum measurement current : 5A

Minimum measurement voltage : 20V

POWER FACTOR**(PF)**

RANGE	ACCURACY	RESOLUTION
0.3~1 Capacitive	±(0.02+2)	0.001
0.3~1 Inductive	±(0.02+2)	0.001

Minimum measurement current : 5A

Minimum measurement voltage : 20V

REACTIVE POWER

$$Q(\text{kVAr}) = UI \sin \phi$$

RANGE	ACCURACY	RESOLUTION
4kVAr	±(4%+5)	0.01kVAr
10kVAr	±(4%+5)	0.01kVAr
40kVAr	±(4%+5)	0.01kVAr
100kVAr	±(4%+5)	0.01kVAr
600kVAr	±(4%+5)	0.1kVAr

Minimum input current : 5A

Minimum input voltage : 20V

Recording Voltage value, current value, Active Power value to calculate Reactive Power value, The calculating accuracy is 0.01% of the range.

ACTIVE ENERGY**(kWh)**

RANGE	ACCURACY	RESOLUTION
1~9999kWh	±(3%+2)	0.001kWh

Minimum measurement current : 0.5A

Minimum measurement voltage : 10V

FREQUENCY		(Hz)
RANGE	ACCURACY	RESOLUTION
20Hz~1kHz	0.5%	0.1Hz

Minimum measurement voltage: 20V

- * Accuracy: % of reading + number of digits

The specification given assume an operating temperature: 18°C~28°C, humidity up to: 80% , the frequency of voltage and current is 45Hz~65Hz

- * Maximum common made voltage: 600V AC RMS
- * Display : LCD 9999
- * Range : autorange
- * Overrange indication: Figure "OL" on the display
- * Reading Holding: Figure "H" on the display
- * Power supply : 4x 1.5V AA
- * Power consume: 250mW
- * Storage temperature: -20°C~70°C
- * Operating temperature: 0°C~40°C
- * Dimension size: 300mm×103mm×51mm
- * Weight: approx. 500g (include battery)

ACCESSORIES

Users manual		1
Battery	1.5V AA	4
Test Leads	(MS3000)	1
Connect test clamp	(MS3102)	1
RS232C interface cable (MS3403)		1
PC Data Record graph software		1
Carry Case		1

